

**Neon® Multi
Krypton® Multi
Manual**



Content

| | | |
|-----------|--|-----------|
| 1. | Neon® Multi and Krypton® Multi | 7 |
| 1.1. | General and safety instructions | 8 |
| 1.2. | Warranty conditions | 9 |
| 1.2.1. | Transport damages | 9 |
| 1.2.2. | Application | 9 |
| 1.2.3. | Intended use | 9 |
| 1.3. | Feature | 10 |
| 1.4. | Technical Data Neon® Multi | 13 |
| 1.5. | Technical Data Krypton® Multi | 14 |
| 2. | Instructions for installation and connections | 15 |
| 2.1. | Dimensions | 15 |
| 2.2. | Installation wall-mounted housing | 15 |
| 2.3. | Connections | 16 |
| 2.3.1. | Connection diagram | 16 |
| 2.4. | Measuring set-up | 19 |
| 2.5. | Installation of Krypton® Multi | 19 |
| 3. | Operation | 20 |
| 3.1. | Desktop | 20 |
| 3.2. | Touch screen operation | 20 |
| 3.2.1. | General | 21 |
| 3.2.2. | Main menu | 21 |
| 3.2.3. | Submenus | 21 |
| 3.3. | Settings | 21 |
| 3.4. | Menu overview – where to look? | 24 |
| 3.5. | Menu appearance depending on code and options | 31 |
| 4. | Code | 32 |
| 5. | Mode | 33 |
| 6. | Analog inputs | 34 |
| 6.1. | Analog input – pH input | 34 |
| 6.2. | Analog input – DIS 1 input | 36 |
| 6.3. | Analog input – temperature measurement | 37 |
| 6.4. | Option analog input – DIS 2 | 38 |
| 6.5. | Option analog input – conductivity measurement | 39 |

Content

| | | |
|------------|--------------------------------------|-----------|
| 7. | Menu cal | 40 |
| 7.1. | Calibrate pH | 40 |
| 7.1.1. | Calibration – run | 40 |
| 7.1.2. | Calibration – Offset | 42 |
| 7.1.3. | Calibration – info | 42 |
| 7.1.4. | Calibration – settings | 42 |
| 7.2. | Calibrate DIS 1/ DIS 2 | 42 |
| 7.2.1. | Calibration – reference | 43 |
| 7.2.2. | Calibration – zeropoint | 43 |
| 7.2.3. | Calibration – offset | 44 |
| 7.2.4. | Calibration – info | 45 |
| 7.3. | Option ORP calibration | 45 |
| 7.3.1. | Calibration – run ORP | 45 |
| 7.3.2. | Calibration – offset | 46 |
| 7.3.3. | Calibration – info | 46 |
| 7.3.4. | Calibration – settings | 46 |
| 7.4. | Option calibrate conductivity | 46 |
| 7.4.1. | Conductivity calibration – reference | 47 |
| 7.4.2. | Calibration – zeropoint | 48 |
| 7.4.3. | Calibration – info | 48 |
| 7.5. | Calibration info | 48 |
| 8. | Digital input | 49 |
| 9. | Test menu | 50 |
| 10. | Memory | 51 |
| 10.1. | Store and upload settings | 51 |
| 10.1.1. | How to save settings | 52 |
| 10.1.2. | How to load settings | 53 |
| 10.2. | Software update | 54 |
| 10.3. | Load languages | 55 |
| 10.4. | How to save the diagnosis file | 56 |
| 11. | System functions | 57 |
| 11.1. | Language | 57 |
| 11.2. | Time | 57 |
| 11.3. | Display | 58 |
| 11.3.1. | Settings | 58 |
| 11.3.2. | Touch Cal | 60 |
| 11.4. | Contact | 61 |

| | | |
|------------|--|-----------|
| 11.5. | Event-related support | 62 |
| 11.6. | Info | 63 |
| 11.7. | Restore factory setting or start configuration | 64 |
| 11.8. | Add-on activation | 65 |
| 12. | Expert menu | 66 |
| 12.1. | Login and access | 66 |
| 12.2. | Start configuration | 67 |
| 12.3. | Schedule | 68 |
| 12.4. | Code | 68 |
| 12.5. | Reset | 69 |
| 13. | Alarm relay | 70 |
| 13.1. | Settings | 70 |
| 13.2. | Alarm action | 71 |
| 13.3. | Alarm confirmation | 72 |
| 14. | Controller | 73 |
| 14.1. | Assignment of control relays | 73 |
| 14.2. | Configuration controller – standard parameter set | 74 |
| 14.2.1. | Priority pH-controller | 75 |
| 14.2.2. | On/off/2 on/off – controller | 75 |
| 14.2.3. | P / PI / PID controller | 75 |
| 14.2.3.1. | P controller | 75 |
| 14.2.3.2. | PI controller | 75 |
| 14.2.3.3. | PID controller | 77 |
| 14.2.4. | Pulsepump/2 pulsepumps | 76 |
| 14.2.5. | dosing pump / 2 dosing pumps | 77 |
| 14.2.6. | Actuator CI | 77 |
| 14.2.7. | Actuator | 77 |
| 14.3. | Configuration controller – second parameter set | 78 |
| 14.4. | Activating and deactivating the controller | 79 |
| 14.5. | Relay display and manual operation of the control relays | 79 |
| 14.6. | Automatic controller stop | 79 |
| 15. | Relay | 81 |
| 16. | Add-on Datalog | 82 |
| 16.1. | View logged data | 84 |
| 17. | Add-on mA output | 85 |

Content

| | | |
|--------------|--|------------|
| 18. | Add-on ASR® | 86 |
| 18.1. | ASR® for DIS 2 | 87 |
| 19. | Add-on Modbus RTU | 88 |
| 19.1. | How to read out data | 88 |
| 19.2. | Communication parameters | 89 |
| 20. | Operation and Maintenance of Neon® Multi and Krypton® Multi | 90 |
| 20.1. | Start-up | 90 |
| 20.2. | Maintenance – operation mode | 90 |
| 20.3. | Maintenance of the measurement | 91 |
| 20.3.1. | Cleaning of sensors | 91 |
| 20.3.2. | Refilling the KCl vessel (with refillable sensors) | 92 |
| 20.3.3. | Cleaning of assemblies, filters, etc. | 92 |
| 20.3.4. | Calibration of the measurement | 94 |
| 20.3.5. | Checking the gaskets | 94 |
| 20.3.6. | Testing the safety features | 94 |
| 20.3.7. | Exchange of consumables | 94 |
| 20.3.8. | Restarting | 95 |
| 20.4. | Decommissioning and disposal | 95 |
| 20.5. | Facilitating functions | 95 |
| 20.5.1. | Store and load settings via SD card | 95 |
| 20.5.2. | Software update via SD card | 95 |
| 20.5.3. | Test menu | 95 |
| 21. | Trouble-Shooting | 97 |
| 21.1. | Useful accessories for trouble-shooting | 97 |
| 21.2. | Contact | 98 |
| 21.3. | Diagnosis file | 98 |
| 21.4. | Info | 98 |
| 21.5. | Event messages | 99 |
| 21.6. | Eventlog | 99 |
| 21.7. | Event help | 99 |
| 21.8. | Events with Popup messages | 108 |
| 21.9. | Reset | 109 |
| Index | | 110 |

1. Neon® Multi and Krypton® Multi

are products by Kuntze Instruments GmbH which offer high quality and long-term reliability, made in Germany.

The multi-parameter Neon® Multi is a cutting-edge measuring and control instrument for industrial disinfectants applications like in breweries, water works or cooling towers.

Updates and add-ons are possible on-site, the instrument is flexible in its build-up and therefore able to keep pace with the growing requirements of the user. The entry-version contains inputs for pH, disinfectant – parameter and measuring range selectable via menu – and temperature, six digital inputs and up to 8 potentialfree relays that can be used as control or alarm relays.

Protect your settings with fixed or user-defined access codes against unauthorized operation. Activate the auto-lock function to make sure that the code is reset after a certain time. Save energy and protect the display with the screensaver function that turns off the background illumination after an adjustable interval.

With the integrated SD card function you can store and load instrument settings, to duplicate software settings to additional instruments or to reinstall your settings after updates or repair.

It provides user support through programmable maintenance schedule and user-defined settings that are automatically uploaded after a reset.

The integrated controller offers PID control for pulse or dosing pumps or servo-motors with or without position feedback, and a second parameter set for less demanding periods such as night-time operation.

You can add

- > ORP measurement
- > A fifth input for sensors with mA output for conductivity
- > A sixth input for for a second measurement of Free or Total Chlorine
- > Data log function to store measured data on the SD card, equipped with trend display
- > Modbus RTU serial interface
- > Our patented automatic sensor cleaning function ASR®
- > Five analog mA outputs

The all-in-one measuring system Krypton® Multi complements all these advantage with a ready-to-use set-up including all necessary components: cables, sensors, assembly, tube connections etc. The assembly StabiFlow® eliminates deviations caused by changing flow rates. It contains a multisensor to monitor temperature and water flow, a filter, and a check valve, and can be used with any of our disinfectant sensors. The patented automatic cleaning function ASR® keeps the electrodes' surfaces clean and active, even in demanding and high-pollution applications.

The assembly can be extended for the ORP / 5th / 6th input add-ons.

Control your water quality at any time, from any place, on any device. The solution is Kuntze Cloud Connect®.

With Neon® and Krypton® you have certainly made a good choice. On the following pages find out more about your disinfectant measurement. If you have further questions or are interested in supplementing products such as sensors, just give us a call - we will be delighted to hear from you!

1. Neon® Multi and Krypton® Multi

1.1. General and safety instructions

This operation manual applies to the following instruments

Instrument type Neon® Multi

SW version V 2.12

The manual contains technical information on installation, operation, and maintenance.

Keep this manual in a place where you can always look up the safety instructions and the information on handling and usage. According to DIN 61010 the manual is part of the product and has to be preserved as long as the instrument is used, and given to the new owner if the instrument is sold.

The instrument was designed, built, and tested according to the directives for electronic devices and has left our company in perfect working condition. To preserve this condition and to ensure safe operation, follow all instructions carefully and pay special attention to all warnings issued in this manual. If the instrument is visibly damaged or has been stored inappropriately or if there are any doubts concerning safe operation, shut it down and make sure it cannot be restarted.

You will notice that certain safety instructions are highlighted:

Warning **highlights instructions for the protection of people. Disregarding warnings may cause accidents and injuries!**

Attention **highlights instructions for the protection of the instrument and equipment. Disregarding these instructions may lead to damage or destruction of the instrument or equipment!**

Note **is used to highlight interesting details.**

1.2. Warranty conditions

We have to point out that the warranties specified in our trading conditions are valid only if the following conditions are met:

- > Installation and start-up by Kuntze personnel or trained and authorized technicians
- > Maintenance of instrument and peripheral equipment according to the instructions of this manual
- > Use according to the designation specified on the following pages
- > Use of original accessories and spare parts only
- > Observance of operation conditions and settings according to this manual

Warranty is void if any one of the conditions listed above is disregarded.

1.2.1. Transport damages

Please check for damages immediately after delivery and report any damages within 24h to the delivering company. Never work with a damaged instrument!

1.2.2. Application

Neon® Multi is used to control industrial disinfection applications in water treatment such as, for example, breweries or drinking water plants. It is used to measure the concentration of Free Chlorine, Chlorine dioxide, Ozone, or Hydrogen peroxide, and pH, temperature and optionally ORP, conductivity and/or total chlorine.

Those parameters are being used for control purposes in many applications. Neon® Multi is equipped with a controller with two set points for each measurement. With these you can control actuators such as dosing pumps or valves to add chemicals until the desired set point is reached. Alternatively, the measured signals can be used as input for an external controller via the instruments' interfaces.

As a safety precaution, measurement and calibration are checked for failure by the instrument. Failures are indicated on the display via text messages that are stored in an eventlog and via the alarm relay and, if activated, as 22 mA current via the analog output.

If the failure makes control unreliable, the controller is automatically switched off until the failure has been taken care of.

Warning **The instrument checks the input signals, calibration results, and the water flow, if a flow sensor is connected. It cannot detect erroneous settings or failures in the treatment system, nor can it check for plausibility! The safety of the system of which the instrument is part of lies within the reach of responsibility of whoever built the system!**

1.2.3. Intended use

Use these instruments only for the monitoring and control of water.

Use only sensors, assemblies, and accessories made by Kuntze, and make sure that they fit your application. Make sure that the required measuring conditions such as flow, pressure, temperature etc. are constantly maintained.

1. Neon® Multi and Krypton® Multi

The measuring system Krypton® provides ideal conditions for the measurement. With the new assembly StabiFlow® it maintains a constant flow independent of pipe pressure. Instructions within this manual that exceed the operation of the instrument refer to the Krypton® system.

Install and operate the instrument according to this manual. Carry out all steps described, and check all measurements and settings before you activate the controller.

Use all available safety measures such as the alarm relay, the 22 mA alarm current, the dosage control, and the low-water indication.

Regularly check that all safety measures are in good working condition!

Warning **The protection built into the instrument is impaired if it is not used as intended!**

1.3. Feature

| Basic instrument | |
|---|--|
| Measuring ranges | |
| Free Chlorine / Chlorine Dioxide / Total Chlorine | Up to 1000µg/l, up to 5.00 / 10.00 / 20.00 mg/l |
| Ozone | Up to 1000µg/l, up to 5.00 / 10.00 mg/l |
| Hydrogen peroxide | Up to 30.00 mg/l |
| pR | 0.00.. 14.00 pH |
| Redox (optionally) | -1500 – 1500 mV |
| 5th measuring input (optionally) | |
| Conductivity | Up to 100.0 mS/cm (with standard signal) |
| 6th measuring input (optionally) | |
| Free Chlorine / Total Chlorine | Up to 1000 µg/l, up to 5.00 / 10.00 / 20.00 mg/l |
| Temperature | 0.0.. -50.0°C |
| Display | Measured values and temperature with units Additional information selectable: contact data, SD card status or relay status |
| Operation | Touch screen |
| Calibration | Guided 2-point calibration (pH only) 1-point calibration against reference, zeropoint calibration possible List of the last 10 calibration results |

| Basic instrument | |
|---------------------------|---|
| Measurement | Free Chlorine, Chlorine Dioxide, Ozone, Hydrogen peroxide or Total Chlorine selectable via menu display as µg/l, mg/l, ppb or ppm pH-value optionally Redox optionally Conductivity optionally second DIS input for Free or Total Chlorine |
| Averaging | Off / low / medium / high, selectable via menu |
| Temperature measurement | With Pt100 or Pt1000, 2-wire or 3-wire connection |
| Temperature compensation | Automatic or manual for each parameter separately selectable |
| Controller options | On/Off controller with adjustable hysteresis P/PI/PID controller as pulse-pulse, pulse frequency, or continuous controller 3 point controller with and without position feedback |
| Parametersets | Up to 3 control parameter sets |
| Hysteresis | Adjustable within the measuring range |
| P range (X_p) | Adjustable within the measuring range |
| Integral time (T_N) | 0 to 2000 seconds |
| Derivative time (T_V) | 0 to 2000 seconds |
| Min. pulse | 0.2 to 9.9 seconds |
| Pulse+pause time | 2 to 99 seconds |
| Max. frequency | 1 to 7200 p/h |
| Start delay | 0 to 200 seconds |
| Dosage check | 0 to 99 minutes |
| Analog input | Potentiometer for position feedback of the actuator (3-point-controller) |
| Digital input 1 | Low water indication Input can be set to NO or NC contact |
| Digital input 2 | External controller stop Input can be set to NO or NC contact |
| Digital input 3 | Level monitoring pH Input can be set to NO or NC contact |
| Digital input 4 | Level monitoring Des Input can be set to NO or NC contact |

1. Neon® Multi and Krypton® Multi

| Basic instrument | |
|-------------------------|--|
| Digital input 5 | ECO contact – activation 2nd parameter set Input can be set to NO or NC contact |
| Digital input 6 | Leakage control or activation 3rd parameter set Input can be set to NO or NC contact |
| Test menu | Operation of relays and outputs, automatic re-entry into the menu after adjustable time |
| SD card | To load and save settings To save the diagnosis file To load software updates To load new languages |
| Autolock | Resets the code to 0000 after a defined period |
| Screensaver | Protect the display by deactivating the illumination after an adjustable interval |
| Event log | Stores up to 100 events |
| Event help | Provides help for current events |
| Add-on | Functions can be added via code |

| Add-ons | |
|--------------------------------|--|
| Analog output 1-5 | 0/4.. 20 mA galvanically isolated, max. load 500 Ohm, 22 mA current selectable via menu To read out measured values, or temperature, or controller output |
| Datalog | measured values, temperature, input signal and controller output selectable Interval adjustable between 1 second and 24 hours Ring or stop mode |
| Digital Interface | Modbus RTU, 19200 bps, 8 bit, 1 stop bit and even parity |
| Automatic sensor cleaning ASR® | Selectable via menu, start time and interval interval (0-7 x/week) adjustable, baseload selectable via menu |

1.4. Technical Data Neon® Multi

| Feature | Neon® Multi |
|-----------------------|---|
| View |  |
| Installation | On boards or walls |
| Dimensions | 260 x 254 x 140 mm |
| Weight | 1.9 kg |
| Connections | Cable inlet: 6x M16, 10x M12 Terminals: rigid / flexible 0.14 - 1.5 mm ² relay/power supply – rigid/flexible 0.2 - 1 / 0.2 - 1.5 mm ² Distribution block 0.5 - 2.5 / 0.5 - 2.5 mm ² |
| Protection class | IP65 |
| Power supply | 85.. 265 V AC, +6/-10%, 40.. 60 Hz |
| Power consumption | 10 VA |
| Contact rating | 8 relay, each a potential free CO contact, max. 250 V, 2A, 550 VA |
| Operation temperature | 0.. 50 °C |
| Storage temperature | -20.. +65 °C |
| Rel. humidity | Max. 90 % rH bei 40°C (non-condensing) |

1. Neon® Multi and Krypton® Multi

1.5. Technical Data Krypton® Multi

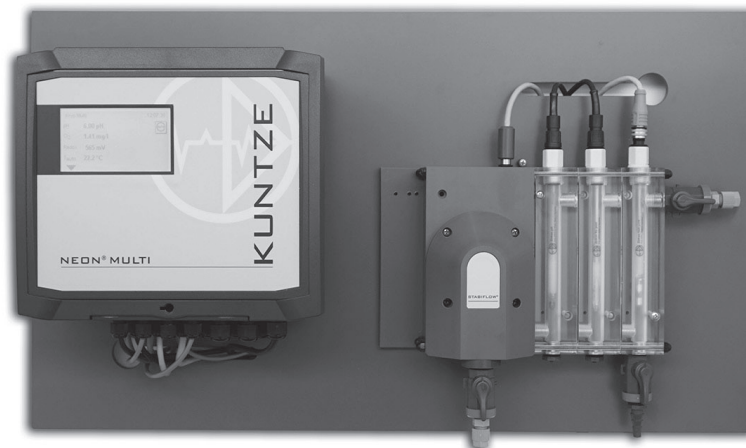

| | |
|---------------------------------|--|
| Assembly StabiFlow® | Inlet and outlet with stop cocks, sampling point, flow control, filter, check valve, multisensor for temperature, flow monitoring and grounding, holder for at least one pH- and one Des sensor – modular set up |
| Sensor Zirkon® DIS | Type 231612500 Gold/gold for Chlorine, Chlorine dioxide and Ozone Type 231714500 Platinum/platinum for Hydrogen peroxide Pool Type 237813500 Platinum/graphite for Chlorine in brine |
| Sensor Zirkon® DIS Total | Typ 239413500 InnoDisk® / platinum for Total Chlorine |
| Measuring cable for Zirkon® DIS | 5SCR-M12-AE-0.8 – screened cable with M12 plug |
| Sensor Zirkon® pH | Type 201012100 All purpose sensor with gel filling and ceramic junction |
| Measuring cable for Zirkon® pH | Coax-D-AE-1.2 – screened pH-cable |
| Multisensor Zirkon® FTG | Pt100 3-wire, flow monitoring, grounding |
| Operating temperature | 0.. 50 °C |
| Storage temperature | -20.. +65 °C |
| Water inlet | 35.. 400 l/h |
| Pressure | Max. 6 bar at 20 °C |
| Min conductivity | > 200 µS/cm |
| pH range | 6.. 8 pH (Free chlorine) 6.. 9 pH (Chlorine dioxide, Ozone, Hydrogen peroxide) 6.. 10 pH (Total Chlorine) |

2. Instructions for installation and connections

Attention Install the instrument in a place where it is not put under mechanical or chemical strain!

Note Mind the protection class!

2.1. Dimensions

Dimensions Neon® Multi

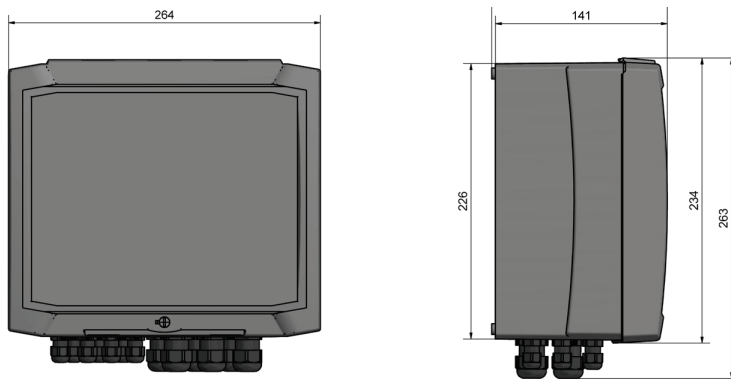

Dimensions Krypton® Multi

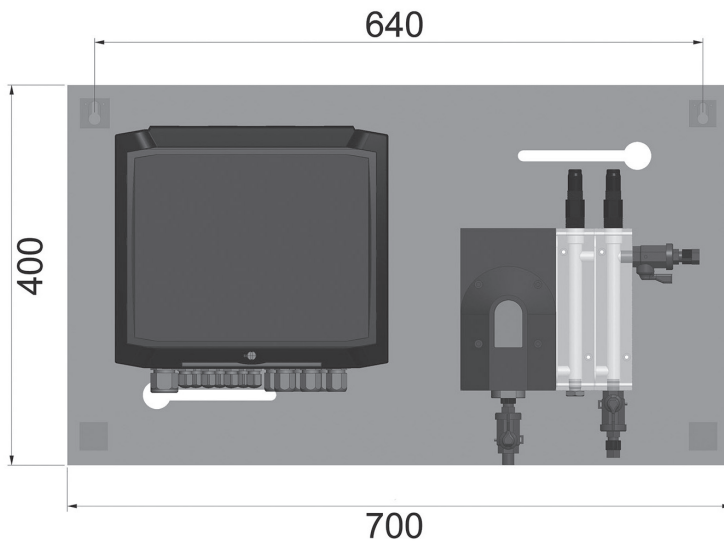

2.2. Installation wall-mounted housing

Drill four holes at 215 mm horizontal distance and 210 mm vertical distance.

Open the instrument and put the screws through the holes at the back of the instrument. Close the instrument or start with the connection.

2. Instructions for installation and connection

2.3. Connections

A detailed connection diagram can be found on the following pages.

Before connecting the power supply check the information on the instrument label!

Warning **Input, output, and control cables must be installed separate from each other and especially apart from power lines!**

For inputs and outputs use screened cables, and connect the screens on one side only.

The measurements are interference-sensitive. Use only our special cables with a very high insulation and keep the distances as short as possible.

For the connection of temperature sensors use a low-resistance cable with a large diameter.

When using the relays, mind that with inductive loads, interference must be suppressed. If that is not possible, the relay must be protected at the terminal block by a resistance-capacity filter or, in case of direct current, by a free-wheeling diode.

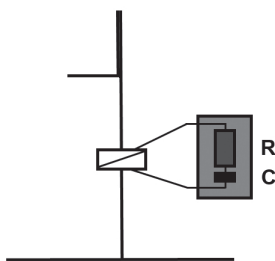

| Current up to | Capacitor C | Resistance R |
|---------------|--------------|----------------|
| 60 mA | 10 nF 260 V | 390 Ohm 2 Watt |
| 70 mA | 47 nF 260 V | 22 Ohm 2 Watt |
| 150 mA | 100 nF 260 V | 47 Ohm 2 Watt |
| 1,0 mA | 220 nF 260 V | 47 Ohm 2 Watt |

2.3.1. Connection diagram

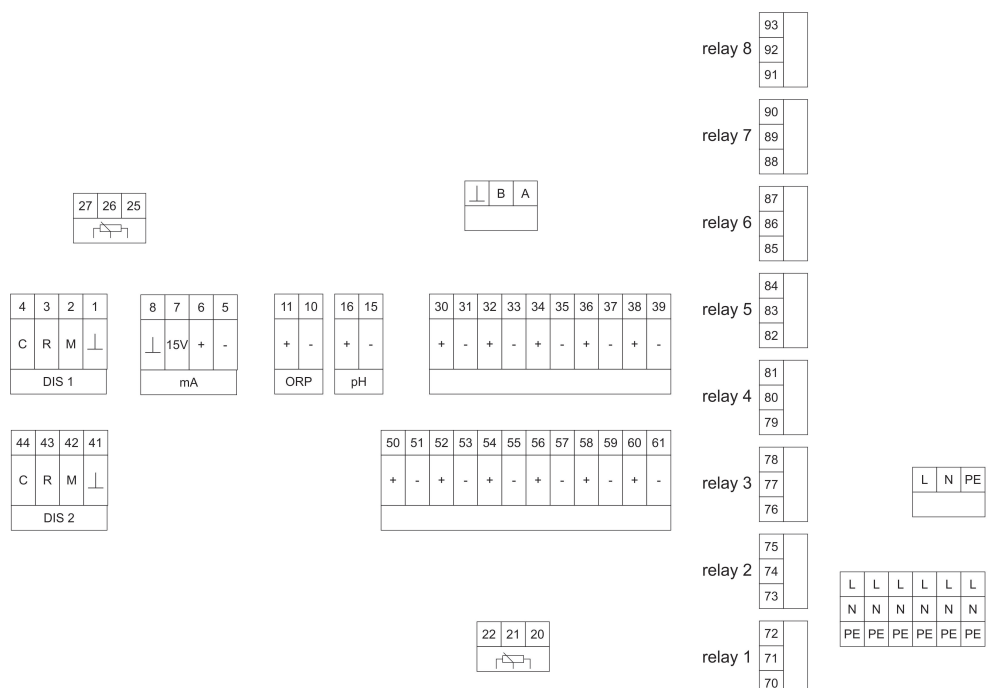

2. Instructions for installation and connection

| Connection | Terminals | Notes |
|----------------|-----------|--|
| DIS 1 sensor | 1 - 4 | 4 = C = counter electrode = blue 3 = R = reference electrode = white 2 = M = measuring electrode = brown 1 = \perp = screen |
| DIS 2 sensor | 41 - 44 | 4 = C = counter electrode = blue 3 = R = reference electrode = white 2 = M = measuring electrode = brown 1 = \perp = screen |
| Standard input | 5 - 8 | 8 = \perp = screen 7 = 15 V = power supply 6 = + = mA 5 = - = E |
| Redox sensor | 10, 11 | 11 = + = measurement = core 10 = - = reference electrode = screen |
| pH sensor | 15, 16 | 16 = + = measurement = core 15 = - = reference electrode = screen |
| Analog output | 30 - 39 | 30, 31 = mA 1 +/-, maximum load 500 Ohm 32, 33 = mA 2 +/-, maximum load 500 Ohm 34, 35 = mA 3 +/-, maximum load 500 Ohm 36, 37 = mA 4 +/-, maximum load 500 Ohm 38, 39 = mA 5 +/-, maximum load 500 Ohm |
| Digital input | 50 - 61 | 50 = - 51 = +, DI 1 = flow control 52 = - 53 = +, DI 2 = external controller stop 54 = - 55 = +, DI 3 = level monitoring 1 56 = - 57 = +, DI 4 = level monitoring 2 58 = - 59 = +, DI 5 = activation 2nd parameter set 60 = - 61 = +, DI6 = activation 3rd parameter set or leakage control |
| Temperature | 20 - 22 | 20 = T1 (Pt100/Pt1000) 21 = T2 (Pt100/Pt1000) 22 = R _L – for 3-wire connection (optionally) Plug the jumper next to terminal 20-22 depending on the used temperature probe (Pt100 or Pt1000) and 2- or 3-wire connection. |

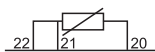
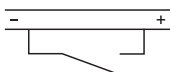

2. Instructions for installation and connection

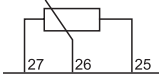
| Connection | Terminals | Notes |
|-------------------|--|--|
| Relay | 70-93  | <p>Relay 1 70+71= NO and 71+72 = NC</p> <p>Relay 2 73+74 = NO and 74+75 = NC</p> <p>Relay 3 76+77 = NO and 77+78 = NC</p> <p>Relay 4 79+80 = NO and 80+81 = NC</p> <p>Relay 5 82+83 = NO and 83+84 = NC</p> <p>Relay 6 85+86 = NO and 86+87 = NC</p> <p>Relay 7 88+89 = NO and 89+90 = NC</p> <p>Relay 8 91+92 = NO and 92+93 = NC</p> |
| Power supply | L+N+PE 6x L/N/PE | 85..265 V AC Power supply for the relays |
| Modbus RTU | A, B, ⊥ | A = + B = - ⊥ = screen |
| position feedback | 25-27  | 25 = 0 % 26 = wiper 27 = 100 % |

Add-ons (marked in grey)

ORP, conductivity, total chlorine, mA outputs, RS 485 Modbus RTU, data logger

2.4. Measuring set-up

Besides the instrument you need sensors for pH and disinfection measurement suitable for the instrument and the application, cables to connect the sensors to the instrument and an assembly to install the sensors in your process. The task of the assembly is to provide the sensor with water in a precise way necessary for a reliable measurement. An ideal set-up represents our measuring system Krypton®, which additionally provides flow control, a filter, and a multisensor for temperature and flow monitoring.

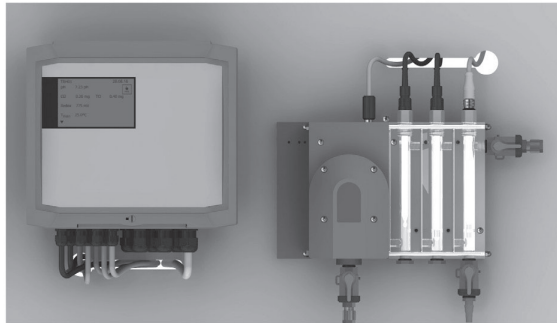

2.5. Installation of Krypton®

The measuring system is delivered ready-to-use and mounted on a PVC board. The board comes with two fastenings to be mounted on a wall. Drill two holes at 640 mm horizontal distance. Insert the plugs included in the delivery, screw the screws into the holes and mount the instrument on the screws via the fastenings.

Water connection

Connect the water inlet at the left stop cock at the bottom of the assembly, and the outlet at the stop cock on the right upper corner. Water has to be supplied at 35...400l/h. The outlet can be an open outlet, or the water can be redirected into a pipe or basin.

Note **Mind that the quality of your measured values strongly depends on how well the measured water matches the water you want to control. Do not take the measured water directly behind the dosing points or from stagnant sections, and avoid long and time-consuming tube connections to the measuring system.**

Take the sensors out of their containers and remove the caps. At works the sensors are installed in KCI containers that have to be removed prior to installation.

Note **We advise to keep the KCI container, closed tightly, and to store the sensors in the container when it is not used.**

Install the sensors in the assembly and connect the cable.

Attention **Tighten the sensors only hand-tight! Do not use heavy tools to avoid damage to the sensors!**

Before you open the inlet, make sure that the stop cock of the sampling point is closed and the outlet is open. For start-up, see chapter Operation and maintenance.

3. Operation

3. Operation

When the power is switched on, the instrument initialises. During that process, the time is displayed.

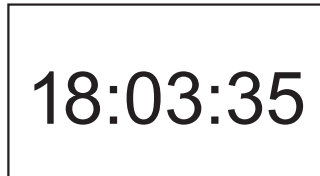

After approx. 20 seconds the process is finished, and the measured values are displayed.

3.1. Desktop

With factory settings, the display shows at the top the instrument name and the time, followed by the current measured value and the temperature.

In the bottom line, the triangular symbol shows the way to the menu (key DOWN, or just touch the triangle if you have a touch screen instrument). On the right side of the bottom line, current events are displayed.

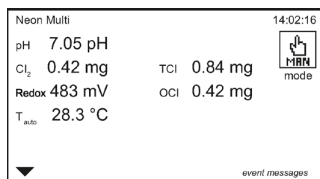

3.2. Touch screen operation

Neon® Multi is operated via touch screen. The screen is of the resistive type, with the advantage that a touch is recognized via pressure – it can be operated even with gloves, and does not respond to mere splashes of water. Press your finger on the screen gently but firmly, and keep the pressure until the instrument shows that the touch has been recognized.

In the desktop (display of the measured values), touching various areas of the screen gives access to different functions and submenus:



Touch

- > **text** to switch to another desktop design
- > **time** to enter the time setting menu
- > **event message** to get suggestions for trouble-shooting
- > the **triangle** to enter the main menu
- > **mode** to change the device mode: AUTO, HOLD and MAN

Note Mind that access might be limited via code. If the current code does not permit access to a selected area, the touch will only yield an empty display. In that case you have to enter the main menu and set a valid code first (0202 for the calibration level, 1612 for full access).

3.2.1. General

In all submenus two symbols are shown in the top right-hand corner:



Home – Touching this symbol takes you back to the desktop from any position.



ESC – Touching ESC takes you back to the previous menu.

3.2.2. Main menu

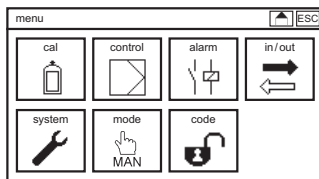

Press the triangle on the left side of the bottom line of the desktop to enter the main menu. In the main menu, select submenus by touching the corresponding symbols.

3.2.3. Submenus

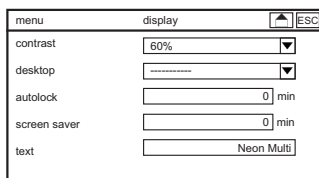

In submenus you will find on the left side the parameters and on the right side the corresponding settings. If the submenu contains more parameters than can be shown, a scroll bar on the right side gives access to the parameters currently not shown.

Move the scroll bar by pulling the bar with your finger or by touching the triangles at the top and bottom of the bar.

3.3. Settings

Parameters are set either by entering a value via keyboard or by selecting a setting from a drop-down list or by activating or deactivating an item from an action list, depending on the nature of the parameter.

Drop-down lists

Drop-down lists appear whenever you have to select a single option from a variety of options, for example when you choose a display design:

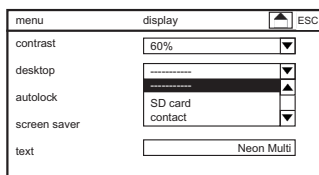

Drop-down lists are indicated by a triangle on the right side of the parameter setting.

3. Operation

Open the drop-down list by touching the triangle. A list of possible settings appears. Select the desired setting via touch. Press ESC if you want to cancel and leave without changing the setting.

Action lists

Action lists appear whenever you can select more than one option from a list, for example alarm actions:

| alarm | action | | | | ESC |
|------------------|-------------------------------------|--------------------------|-----------------------|--------------------------|-----|
| | R5 | R6 | R7 | R8 | |
| zeropoint | <input checked="" type="checkbox"/> | <input type="checkbox"/> | <input type="radio"/> | <input type="checkbox"/> | |
| slope | <input checked="" type="checkbox"/> | <input type="checkbox"/> | <input type="radio"/> | <input type="checkbox"/> | |
| check pH input | <input checked="" type="checkbox"/> | <input type="checkbox"/> | <input type="radio"/> | <input type="checkbox"/> | |
| check Des input | <input checked="" type="checkbox"/> | <input type="checkbox"/> | <input type="radio"/> | <input type="checkbox"/> | |
| check ORP input | <input checked="" type="checkbox"/> | <input type="checkbox"/> | <input type="radio"/> | <input type="checkbox"/> | |
| check Temp input | <input checked="" type="checkbox"/> | <input type="checkbox"/> | <input type="radio"/> | <input type="checkbox"/> | |

Action lists contain all selectable items. Each item has a box that can be ticked, whether right or left (sometimes in two rows).

Press the desired option with your finger to tick or untick its box.

Note Options that are not activated in your instrument are crossed out and cannot be ticked.

Neon®'s support with the settings:

Parameters that do not fit to previous selections are not shown.

Example:

If you have selected automatic temperature compensation, setting a manual value is unnecessary. Accordingly, manual temperature is replaced by temperature coefficient.

| in/out | temp | ESC |
|--------------|---------|-----|
| type | Pt100 | |
| correction | 0.0 °C | |
| temp. coeff. | 0.0 %/K | |
| reference | 25.0 °C | |
| mode | auto | |

Entering a value/keyboard

For settings of a freely adjustable parameter, like limit values or contact data, a keyboard appears if you select the input field by touching the settings box of the parameter.

On the right side of the keyboard, four function keys are shown:

- > The upmost function key shows „123“ or „**abc**“ and allows changing from characters to numbers and vice versa.
- > The „**C**“ (clear) key erases the last input
- > The „**AC**“ (all clear) key erases the complete input
- > The „**OK**“ acknowledges the selection

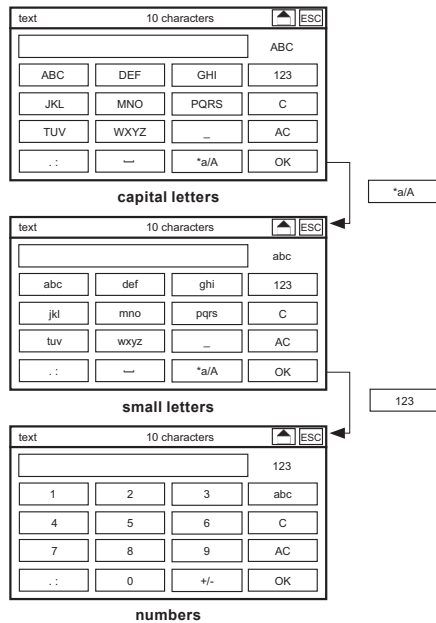

Note With numerical parameters, the keyboard automatically shows only numbers.

Simply select numbers and characters by pressing the field. If a key represents several characters touch it twice for the middle character or three times for the right character.

Touch OK when the input is complete. Now the instrument checks if the input is within the allowed limits. If it is, the new value is stored, and the setting is finished. The keyboard disappears.

If the value does not lie within the allowed limits, the value is not stored. The input field turns dark, and the keyboard remains open until you enter a correct value or cancel the setting and touch ESC or home.

Note For maximum comfort the instrument adds zeros automatically. An input of pH 4, for example, is automatically turned into 4.00, and an input of 1 for the datalog interval is automatically interpreted as 00:00:01 (hours:minutes:seconds). Unfortunately, for date, code, add-on codes, text, and contact data, this support is not feasible.

3. Operation

3.4. Menu overview – where to look?

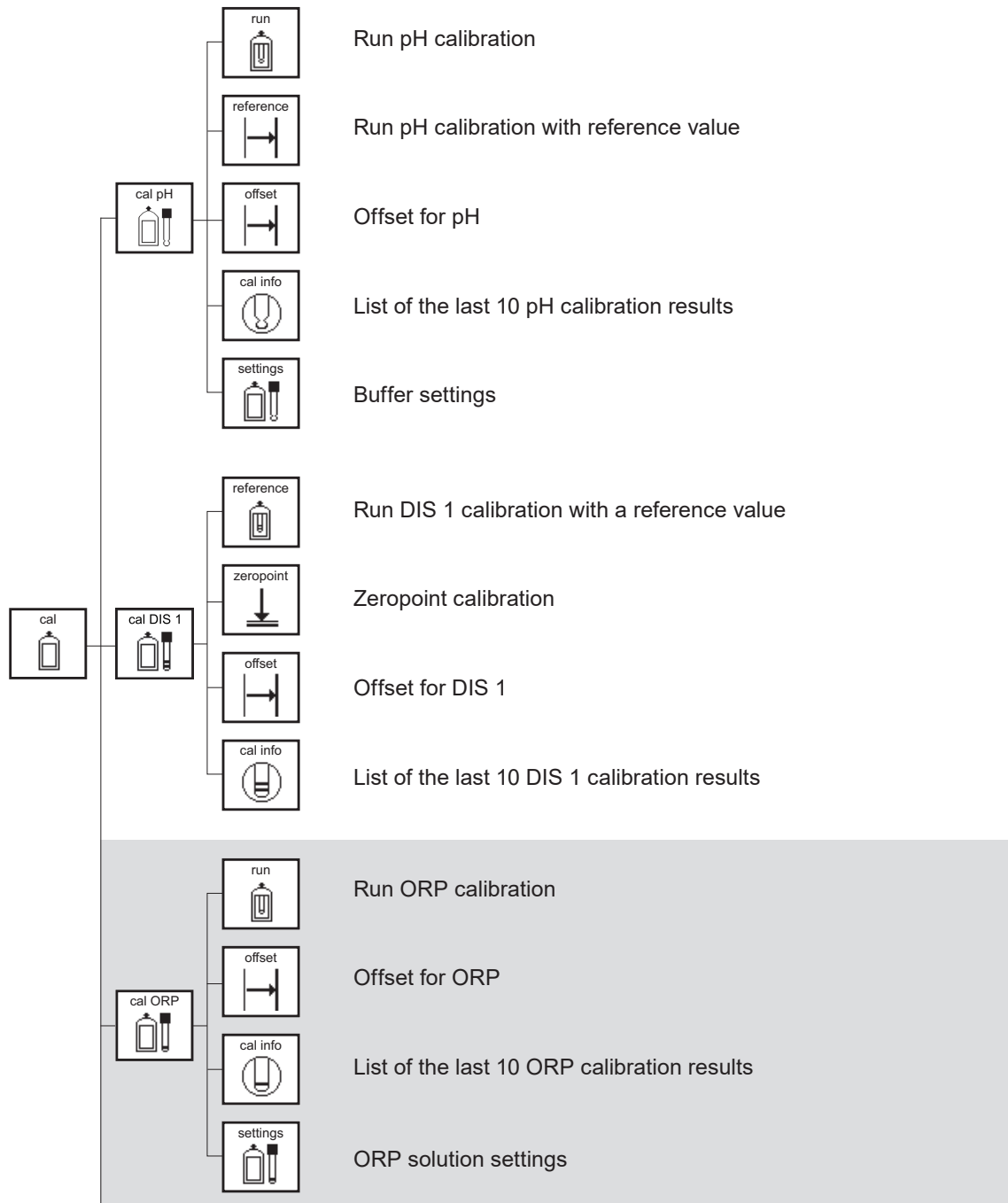

Add-ons (marked in grey)

ORP, Conductivity, Total Chlorine, mA outputs, RS 485 Modbus RTU, data logger and automatic sensor cleaning ASR®

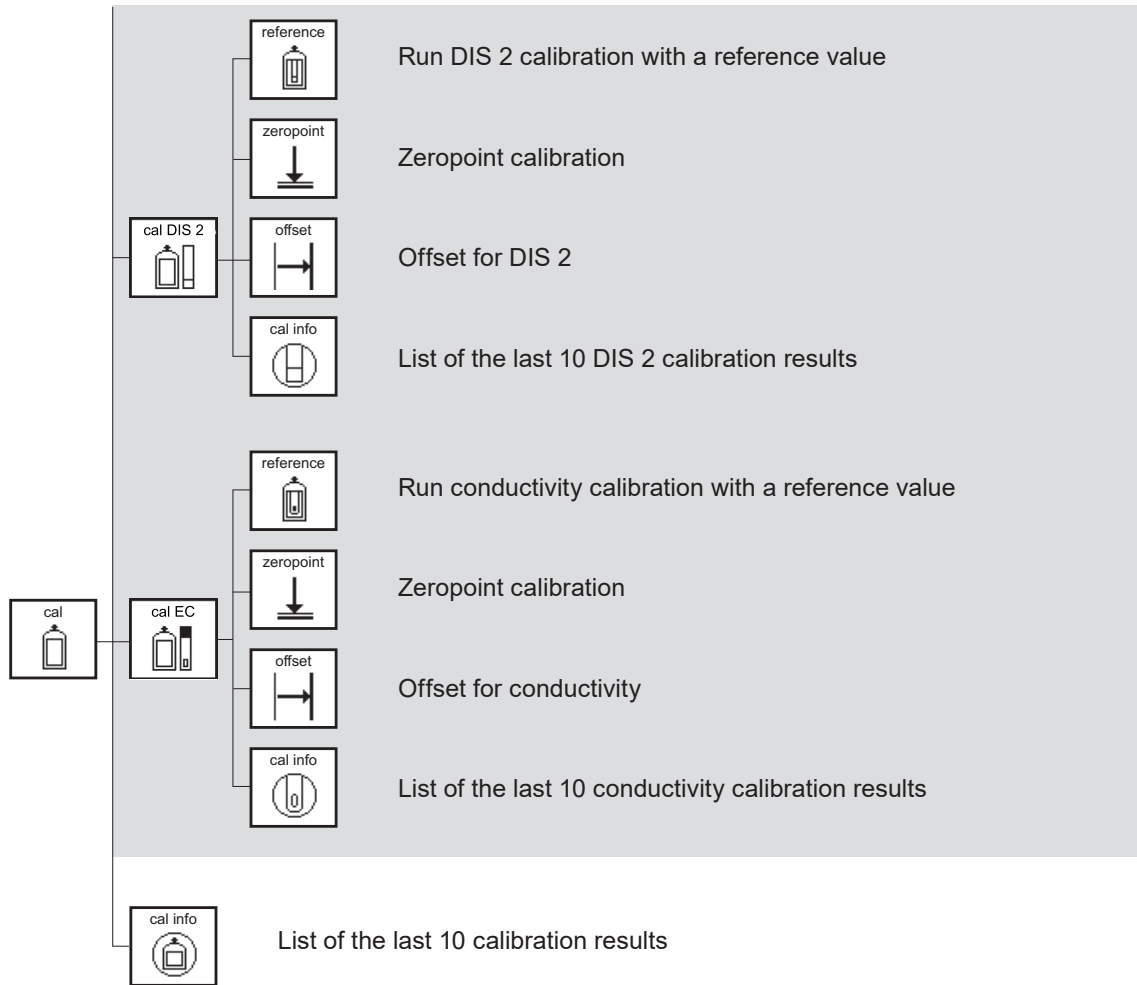

Add-ons (marked in grey)

ORP, Conductivity, Total Chlorine, mA outputs, RS 485 Modbus RTU, data logger and automatic sensor cleaning ASR®

3. Operation

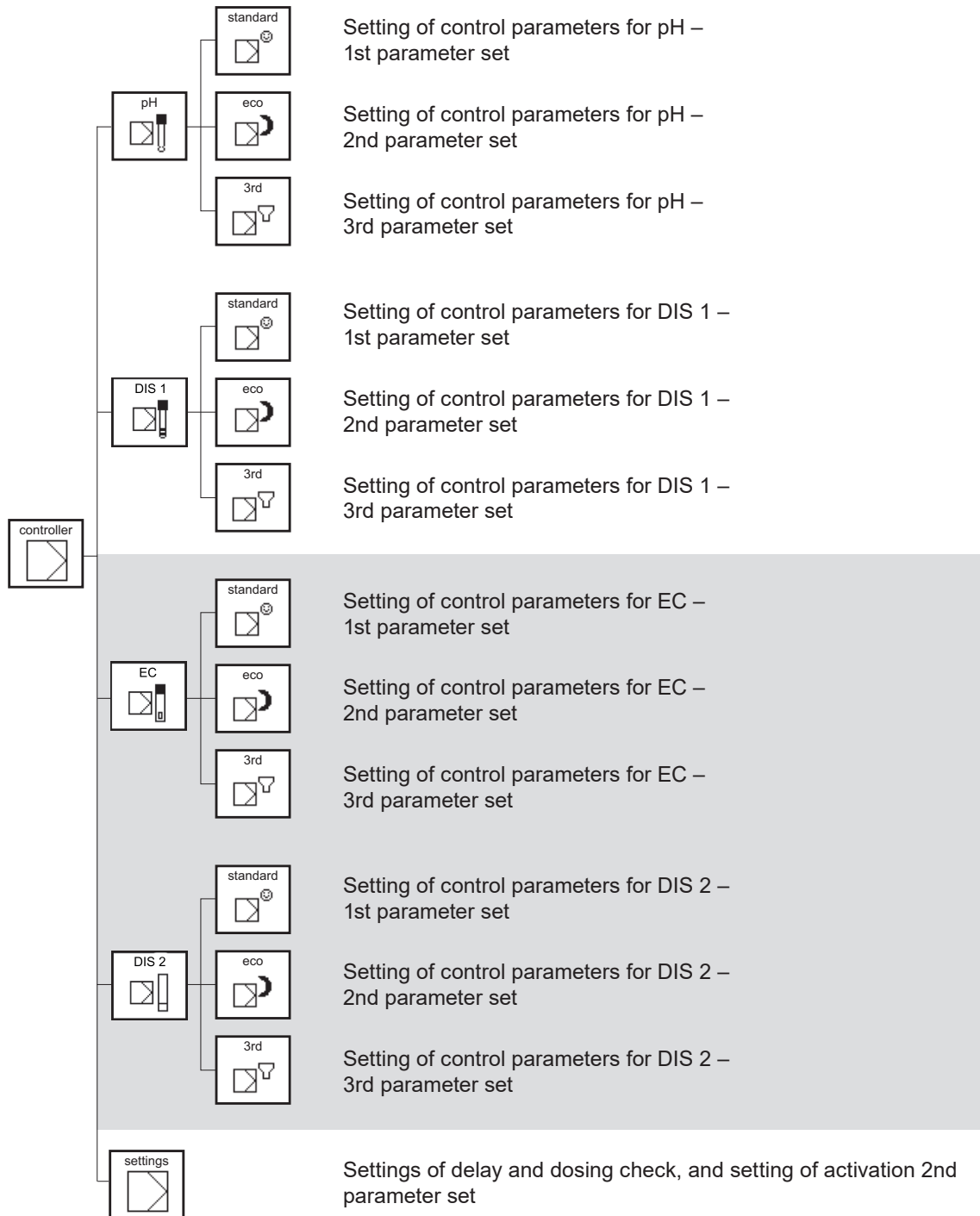

Add-ons (marked in grey)

ORP, Conductivity, Total Chlorine, mA outputs, RS 485 Modbus RTU, data logger and automatic sensor cleaning ASR®

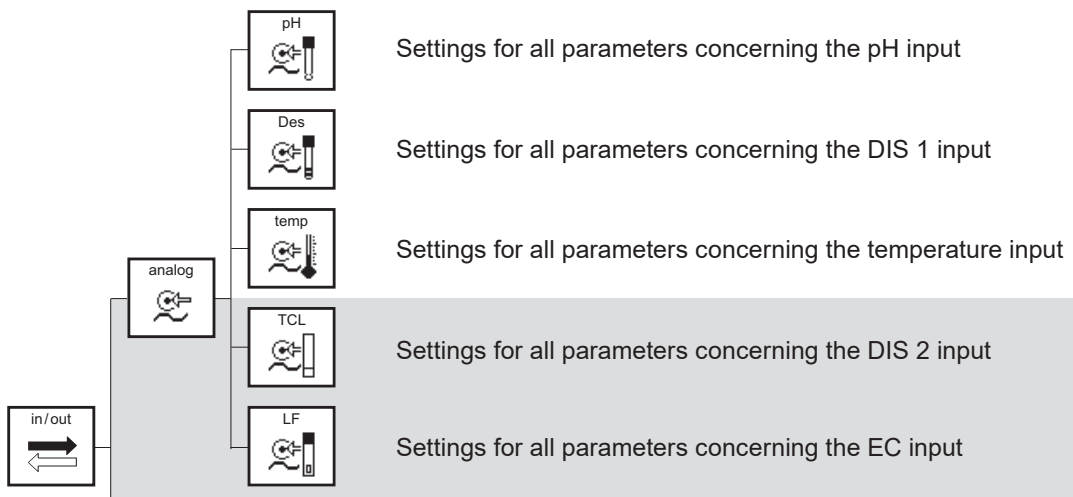
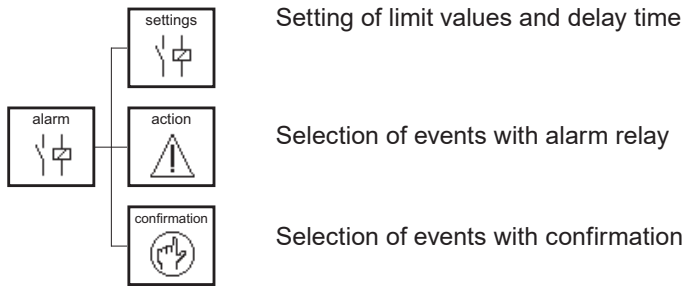

Add-ons (marked in grey)

ORP, conductivity, total chlorine, mA outputs, RS 485 Modbus RTU, data logger and automatic sensor cleaning ASR®

3. Operation

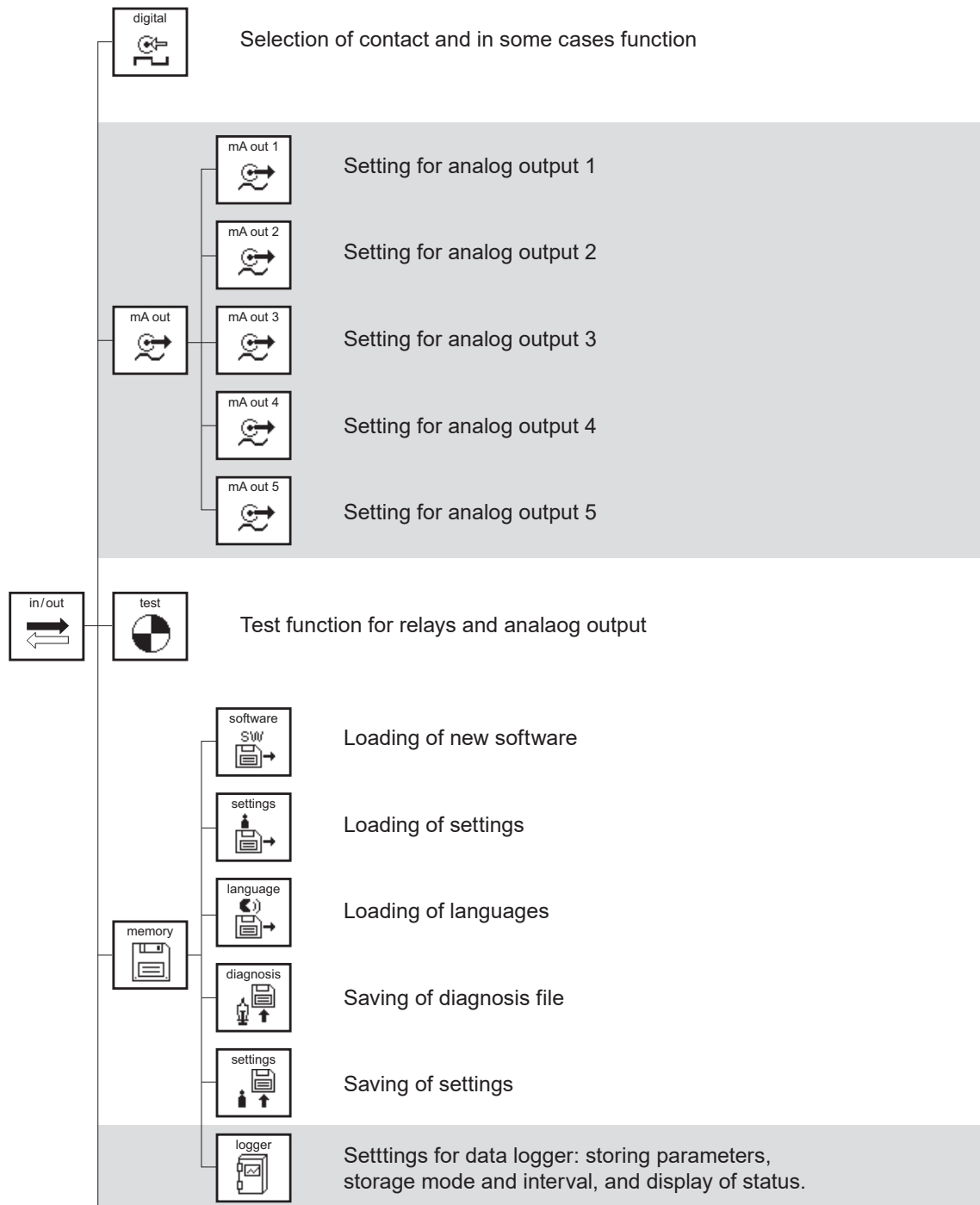

Add-ons (marked in grey)

ORP, conductivity, Total Chlorine, mA outputs, RS 485 Modbus RTU, data logger and automatic sensor cleaning ASR®

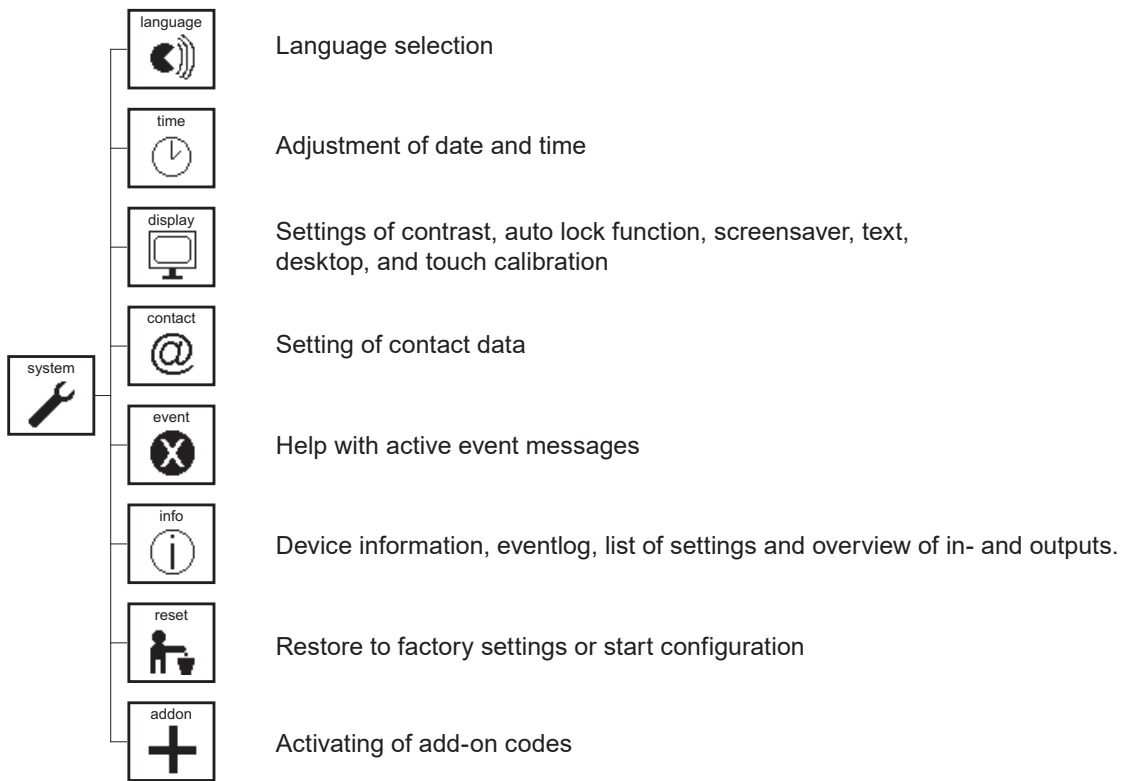
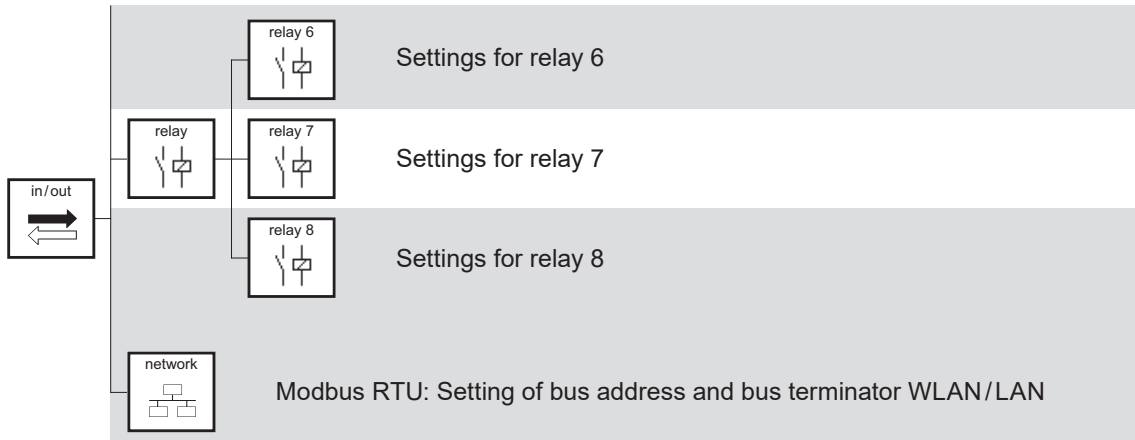

Add-ons (marked in grey)

ORP, Conductivity, Total Chlorine, mA outputs, RS 485 Modbus RTU, data logger and automatic sensor cleaning ASR®

3. Operation



Selection of device mode: man, hold or auto



Entering a code



Login



Saving of start configuration



List of changes since the last login



Setting of schedule for calibration, cleaning and sensor changing



Setting of individual user codes



Restore to factory settings including expert menu

Add-ons (marked in grey)

ORP, Conductivity, Total Chlorine, mA outputs, RS 485 Modbus RTU, data logger and automatic sensor cleaning ASR®

3.5. Menu appearance depending on code and options

The main menu and the submenus appear different, depending on code, add-ons, and settings.

No valid code

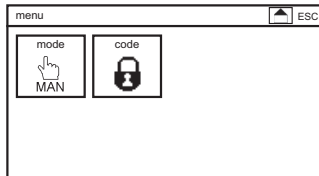

If no valid code is set, the main menu shows only two symbols, one to enter another code, and the other to stop the controller.

When the code is set to 1612 for user level or 1818 for expert level the menu is shown dependent on level and available add-ons.

User level

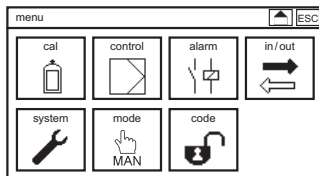

Expert level

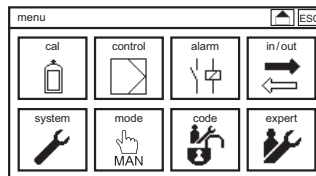

Note

Menus which are not active due to previous settings are not shown in the menu.

4. Code

4. Code

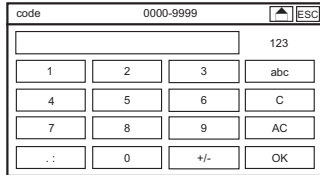
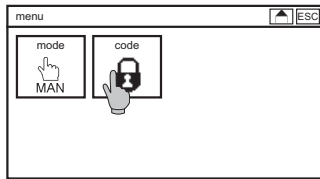

To enter a code, select the symbol CODE from the main menu, and enter the code via the keyboard.

The Neon® Multi instruments have three access levels, which are set via code:

Calibration level code: 0202

On this level you can calibrate, save settings, events and the diagnosis file, and view various settings.

Full access code: 1612

On this level you can enter and change all main menu functions and settings.

Expert code: 1818

On this level you have access to all functions including the expert menu. In the expert menu, the instrument automatically resets the code to 0000 after 10 minutes without operation.

If the expert level is set, the CODE symbol in the main menu shows a lock with an expert.

Invalid code or calibration level



user level

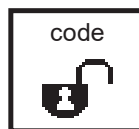

expert level

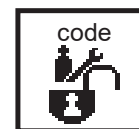

Autolock function

On delivery, the autolock function is deactivated. If you activate it via menu, the code is reset to 0000, to prevent unauthorized operation, after a defined interval without operation, or whenever the power supply was cut off. For more information, see the chapter "System functions".

5. Mode

There are three modes of operation. To change the operation mode, select the symbol MODE. The symbol changes according to settings.

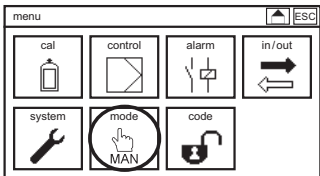
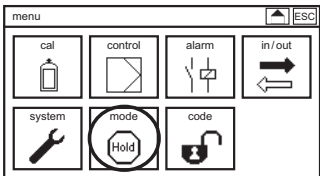
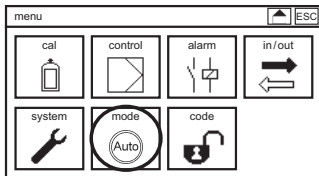
| MAN | Hold | Auto |
|---|---|---|
|  |  |  |
| <ul style="list-style-type: none"> > Desktop display active > Alarm relay active > Test functions active > Limits active > Data log active > mA outputs active > Controller OFF > Modbus RTU active | <ul style="list-style-type: none"> > Desktop display active > Alarm relay deactivated > Test functions deactivated > Limits deactivated > Data log on HOLD > mA outputs on HOLD > Controller OFF > Modbus RTU on HOLD | <ul style="list-style-type: none"> > Desktop display active > Alarm relay active > Test functions deactivated > Limits active > Data log active > mA outputs active > Controller ON > Modbus RTU active |

Note **The instrument shows always only the features that you have purchased. In the entry-level version, the instruments contains the desktop, the alarm relay, the test functions, the controller, and the limits.**

In operation mode auto Neon® Multi stops automatically the controller if

- > one of the digital inputs switches (low water, external controller stop, level pH and level Des and leakage)
- > there is no measuring value (check measuring input, check temperature input)
- > dosage check is activated
- > for disinfection and free chlorine during automatic cleaning

6. Analog outputs

6. Analog inputs

Select the symbol IN/OUT in the main menu and then the symbol ANALOG.

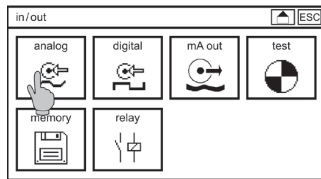
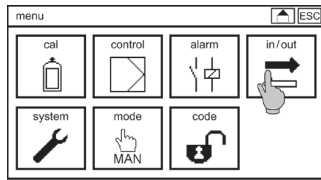

In the submenu ANALOG you can choose between the activated measuring inputs: pH, DIS 1, temperature, conductivity or DIS 2.

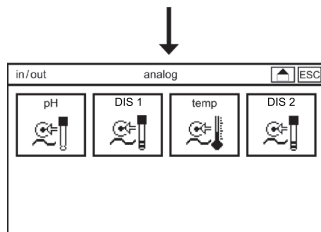

6.1. Analog input – pH input

In the submenu IN/OUT => ANALOG => pH you can make all settings concerning the pH measurement.

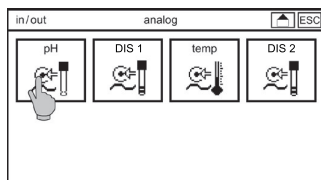

Choose in the main menu the symbol IN/OUT and in the submenu the symbol ANALOG and pH in the submenu.

Temperature compensation

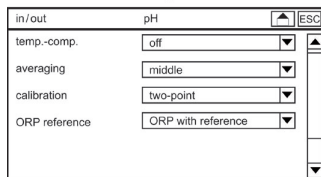

If you activate the temperature compensation the pH value is automatically compensated to a reference temperature of 25° C.

Note The compensation compensates only the temperature effect on the sensor, not on the buffers and solutions.

Note Mind that the temperature sensor should always measure the temperature in the vicinity of the pH sensor. If the two sensors are not in the same solution, for example during calibration, switch to manual compensation.

Averaging

To activate the averaging function select:

- > off: no averaging
- > low: mean of 5 values
- > middle: mean of 10 values
- > high: mean of 20 values

Calibration

The two-point-calibration compensates offset and slope of the electrode and assures high accuracy.

For some measurements, especially within the scope of quality assurance, the absolute pH value is not of interest but the pH value in comparison to a reference substance. In this case a one-point-calibration is possible, while the slope is fixed at the theoretical value of -59 mV/pH at 25° C .

Note **With a one-point calibration the result of the pH measurement is just an indication that pH is kept within a tolerance range around the reference value, not an absolute pH value.**

ORP reference

Choose ORP with reference or ORP without reference depending on the used ORP sensor (with or without reference electrode)

Note **If you choose ORP without reference connect only the measuring electrode of the ORP sensor to the instrument. The reference electrode of the pH measurement will be used for the ORP measurement. Mind that both sensors are in the same solution. If they are not in the same media, for example during pH calibration the ORP measurement shows unreasonable measuring values.**

Note **Calibration of an ORP measurement without reference is not possible.**

6. Analog outputs

6.2. Analog input – DIS 1 input

All settings concerning the disinfection measurement are found in the submenu IN/OUT => ANALOG => DIS 1.

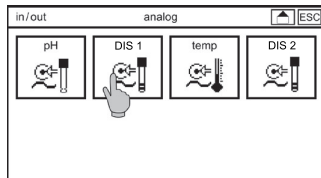

Select the symbol IN/OUT in the main menu, ANALOG in the submenu and then DES.

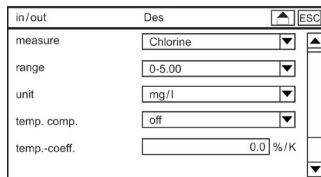

Measure

To select the parameter, select Chlorine, Chlorine dioxide, Ozone, Hydrogen peroxide or Total Chlorine.

NOTE Never calibrate directly after changing the parameter: if the sensor is connected, the sensors needs time to repolarise to the new parameter.

Measuring range

Dependent on the parameter you can select different measuring ranges:

- > Chlorine or Chlorine Dioxide or Total Chlorine: Up to 1000 µg/l, up to 5.00 / 10.00 / 20.00 mg/l
- > Ozone: Up to 1000 µg/l, 5.00 / 10.00 mg/l
- > Hydrogen Peroxide: Up to 30.00 mg/l

Warning Whenever you change the measuring range, the instrument automatically changes the settings for current outputs, controller, and limits. Check these settings after changing the measuring range!

Display unit

Here you can switch from mg/l to ppm and vice versa. For the up to 1000µg/l measuring range you can choose between µg/l and ppb.

Temperature compensation

If you activate the temperature compensation the disinfection value is automatically compensated to a reference temperature of 25°C.

Temperature coefficient

Via the temperature coefficient you can adjust the compensation. The coefficient defines the amount of compensation as % correction per degree and depends on temperature and concentration. For many applications, a coefficient of 2%/K has proved advantageous. For small concentrations and temperatures close to 25° C the setting can usually be left at 0%/K.

NOTE **Since large temperature fluctuations are rare in disinfection applications, the main role of temperature compensation is the correct interpretation of low slope values in cold water to prevent slope error messages.**

Averaging

To activate the averaging function select:

- > off: no averaging
- > low: mean of 5 values
- > middle: mean of 10 values
- > high: mean of 20 values

pH compensation

You can compensate the pH impact on the free Chlorine measurement to prevent deviations caused by pH fluctuations. Unaffected of the compensation there is signal loss of the free Chlorine measurement with rising pH values. For all other parameters the pH compensation is deactivated and not shown in the menu.

Note **After activation of the compensation you need to recalibrate**

pH compensation is available only for DIS 1 and only when DIS 1 is set to Chlorine.

6.3. Analog input – temperature measurement

In the submenu IN/OUT => ANALOG => TEMP you can find all necessary parameters for temperature measurement. Choose in the main menu the symbol IN/OUT and in the submenu the symbol ANALOG and in the submenu TEMP.

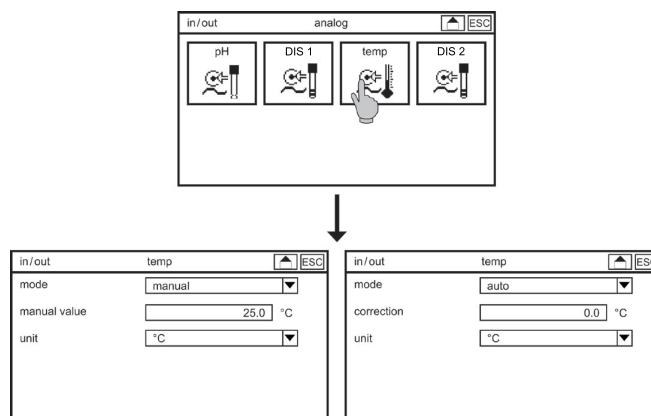

6. Analog outputs

Mode

In the automatic mode, the measured temperature values are used to compensate the temperature influence on the measurement, and in the manual mode, a manual temperature setting is used. In the automatic mode, the measured temperature is displayed on the desktop and given out via analog and digital outputs. In the manual mode, the manual temperature is displayed and given out.

Note **The measuring values are always compensated to a reference temperature of 25° C.**

Manual value

Enter the temperature of your solution for manual compensation. If you want to deactivate temperature compensation, set the manual value to the same value as the reference temperature and set mode to manual.

Note **This parameter is only shown in manual mode.**

Correction

If the sensor is connected with a 2-wire cable, slight deviations might occur between measured and real temperature. Check the temperature once during installation, and calibrate the temperature measurement if necessary by entering a correction value between -10° C and +10° C.

Note **This parameter is only shown in automatic mode.**

6.4. Option analog input – DIS 2

If you have activated DIS 2, you can connect a second disinfectant measurement for either Free or Total Chlorine.

All settings concerning DIS 2 measurement are found in the menu IN/OUT => ANALOG => DIS 2.

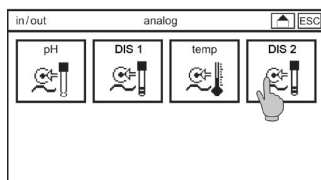

Select the symbol IN/OUT in the main menu, ANALOG in the sub-menu, and DIS 2 in the submenu.

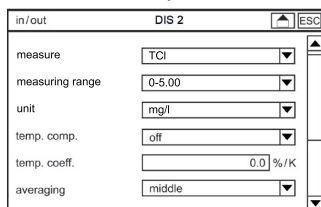

Organic Chlorine

If you activate organic Chlorine the amount of organic Chlorine is calculated from the measuring values of free Chlorine and total Chlorine. The organic Chlorine value is shown on the display and given out via the interfaces.

Note **You can only activate organic Chlorine if your disinfection measurement input is set to free Chlorine.**

Temperature compensation

If you activate the temperature compensation the total Chlorine value is automatically compensated to a reference temperature of 25° C.

Temperature coefficient

Via the temperature coefficient you can adjust the compensation. The coefficient defines the amount of compensation as % correction per degree and depends on temperature and concentration. For many applications, a coefficient of 2%/K has proved advantageous. For small concentrations and temperatures close to 25° C the setting can usually be left at 0%/K.

Averaging

To activate the averaging function select:

- > off: no averaging
- > low: mean of 5 values
- > middle: mean of 10 values
- > high: mean of 20 values

6.5. Option analog input – conductivity measurement

Note **With Neon® Multi you can only use a conductivity sensor with standard output 4-20 mA.**

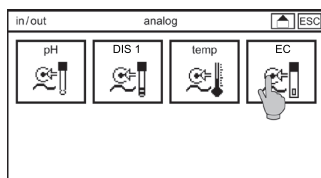

Select the symbol IN/OUT, in the submenu ANALOG and then in the submenu EC.

Averaging

To activate the averaging function select:

- > off: no averaging
- > low: mean of 5 values
- > middle: mean of 10 values
- > high: mean of 20 values

7. Menu cal

7. Menu cal

Set the controller to MAN or HOLD: MAN stops the controller, all other functions are still active. HOLD stops the controller, all outputs are frozen to the last value and the alarm relay is deactivated.

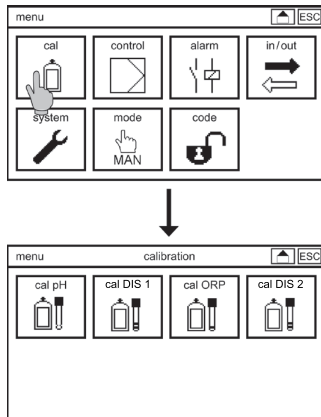

Select the symbol CAL to enter the submenu CALIBRATION and select the parameter for calibration.

7.1. Calibrate pH

Mind the temperature compensation! For automatic compensation, the temperature sensor has to be put in the calibration buffers together with the pH sensor. If that is not possible, switch to manual mode and enter the temperature of the buffer solutions manually.

7.1.1. Calibration – run

Note You can leave the calibration menu any time with ESC, and with touch screen operation also with the HOME symbol.

> Select the symbol RUN to start the calibration.

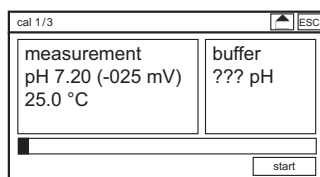

> Put the pH sensor in the first buffer solution and press START. Default values for the buffer solutions are pH 4 and pH 7. If you want to use other buffer solutions, you have to change the calibration settings.

> The automatic buffer recognition starts. When it is finished, the right window shows the recognized buffer.

> When the measured value stabilizes, or at the latest after 120 seconds, the process bar is complete, and an OK button appears.

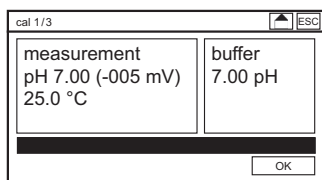

Note If the measured value is still not quite stable after the 120 seconds, as can be the case with older sensors, wait until it stabilizes, and then press OK.

- > With the OK button you execute the first calibration point and reach the second step of the calibration process.

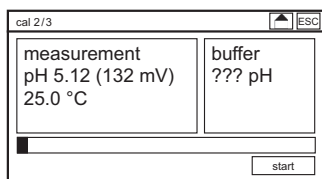

- > Rinse the sensor with water, dry it with a soft tissue, and place it in the second calibration buffer.
- > Start the second calibration step with the START button.
- > When the second step stabilizes, or at the latest after 120 seconds, the process bar is complete, and an OK button appears.

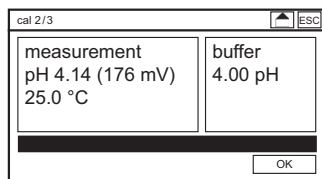

- > With OK you execute the second calibration point and reach the info screen, showing the results of the calibration.

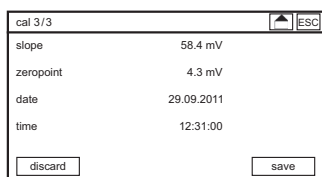

- > With the SAVE button you store the results. With DISCARD you reject the results and keep the previous calibration values.

Note If the slope does not lie within 50mV and 65mV per pH, or the zero point not within -60mV and +60mV, an event message is displayed. If the calibration process has been carried out proper and correct, these messages indicate that the sensor is worn out and has to be replaced as soon as possible. Refer to the eventlog or the chapter “Trouble shooting” for more information.

7. Menu cal

7.1.2. Calibration – Offset

If there is a constant difference shown between measuring value and a manually measured value caused by outside influences compensate the difference by defining an offset.

- > Select pH CAL in the menu and OFFSET in the submenu.

| | |
|--|-------------------|
| measure pH 7.00 with offset pH 7.10 | offset 0.10 pH |
| OK | |

- > Enter the offset as a difference between the manual measurement and the displayed value and confirm with ok.

7.1.3. Calibration – info

If you select the symbol INFO in the submenu CAL, you get a list of the last calibrations. This is helpful with regard to predictive maintenance.

If you select SETTINGS in the submenu CAL, you see the current settings for buffer solutions and internal buffer, and can change the settings if you want to use other solutions or a sensor with a special internal buffer.

| calibration | info | | |
|-------------|----------|---------|---------|
| 24.04.2012 | 14:08:56 | 58.4 mV | 4.3 mV |
| 21.04.2012 | 13:58:32 | 54.2 mV | 37.9 mV |
| 15.02.2012 | 14:24:38 | 56.4 mV | 24.0 mV |
| 08.01.2012 | 15:02:16 | 57.2 mV | 18.6 mV |
| 28.11.2011 | 13:30:01 | 57.7 mV | 12.3 mV |
| 21.09.2011 | 09:28:36 | 57.9 mV | 8.5 mV |

7.1.4. Calibration – settings

| | | |
|----------|------|----|
| buffer 1 | 4.00 | pH |
| buffer 2 | 7.00 | pH |

If you select SETTINGS in the submenu CAL, you see the current settings for buffer solutions and internal buffer, and can change the settings if you want to use other solutions or a sensor with a special internal buffer.

Note The pH values of the buffers are given for a certain temperature. If you calibrate at a different temperature, select the correct pH value from the table on the buffer bottle. The temperature compensation compensates only the temperature influence on the measurement, not on the buffers!

7.2. Calibrate DIS 1 / DIS 2

Note The calibration menus for all disinfection measurements are identical.

A water sample is taken at the outlet of the assembly, and the disinfectant concentration in that sample is determined by a reference method. Find more information on that in the chapter Operation and maintenance.

For Total Chlorine measurements we recommend to wait at least 30 minutes after installation before the first calibration.

7.2.1. Calibration – reference

Note You can leave the calibration menu any time with ESC, and with touch screen operation also with the HOME symbol.

- > Select the symbol REFERENCE to start the calibration.

- > Take a water sample from the outlet of the assembly or at the sampling point, and determine the disinfectant concentration with a comparison method. Enter this value as Reference.
- > With OK you execute the calibration and reach the info screen, showing the results of the calibration.

- > With the SAVE button you store the results. With DISCARD you reject the results and keep the previous calibration values.

Note If the slope is insufficient, an event message is displayed. If the calibration process has been carried out proper and correct, this message indicates that the sensor is worn out and has to be replaced as soon as possible. Refer to the eventlog or the chapter “Trouble shooting” for more information.

7.2.2. Calibration – zeropoint

Note In most applications, zeropoint calibration is absolutely unnecessary and worse, can lead to problems with the measurement or the reference calibration. Zeropoint calibration is sensible only when a significant and constant zeropoint deviation is caused by water ingredients that do not react with the disinfectant, and for Total Chlorine.

Warning The zeropoint calibration can have dire consequences if done improperly! If, for example, a zeropoint deviation is due to substances that consume disinfectant and are through that process themselves consumed, it would be wrong to make a zeropoint calibration. Instead, the measurement has to be relocated to a point at which the consumption reaction is already complete!

- > For zeropoint calibration supply the measuring point with disinfectant-free water that in every other respect and in all measuring conditions corresponds to your measuring water. Suitable is for example a measurement prior to disinfectant dosing. Removing disinfectant with chemicals on the other hand may change the water and the resulting zeropoint.

7. Menu cal

Note For Chlorine Dioxide measurements you can check the zero point, if you can not measure disinfectant-free water, by taking a water sample at the measuring point and let it stand open for a while, preferably while stirring, until the disinfectant has evaporated. If you now stir the sensor in that sample, the measurement, while instable, will give you an idea on what value you would get as zeropoint. Do a zeropoint calibration only if the value deviates significantly from zero.

> In the CAL menu, select ZEROPOINT.

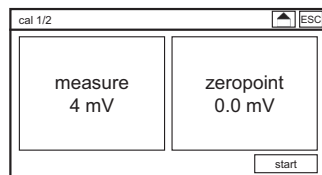

> With OK you execute the calibration and reach the info screen, showing the results of the calibration.

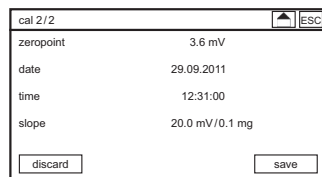

> With the SAVE button you store the results. With DISCARD you reject the results and keep the previous calibration values.

Note After zeropoint calibration you have to carry out a reference calibration.

Note If following a zeropoint calibration you encounter difficulties with the measurement or the reference calibration, we strongly recommend to undo the zeropoint calibration by disconnecting the cable from the sensor and repeating the zeropoint calibration as soon as the measuring signal has dropped to 0mV.

7.2.3. Calibration – offset

If there is a constant difference shown between measuring value and a manually measured value caused by outside influences compensate the difference by an offset.

> Select DIS 1 CAL in the menu and OFFSET in the submenu.

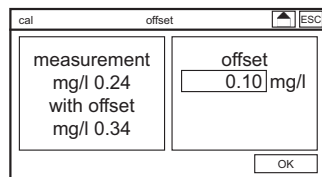

> Enter the offset as a difference between the manual measurement and the displayed value and confirm with ok.

7.2.4. Calibration – info

| Kalibrierung | | Info | |
|--------------|----------|---------|--------|
| 24.04.2012 | 14:08:56 | 20.0 mV | 0.0 mV |
| 21.04.2012 | 13:58:32 | 3.4 mV | 0.0 mV |
| 15.02.2012 | 14:24:38 | 8.9 mV | 0.0 mV |
| 08.01.2012 | 15:02:16 | 13.9 mV | 0.0 mV |
| 28.11.2011 | 13:30:01 | 20.2 mV | 0.0 mV |
| 21.09.2011 | 09:28:36 | 23.5 mV | 0.0 mV |

Select the symbol INFO in the CAL menu to view the last calibration results. This allows predictive maintenance.

In the example above, the slope decreases over time. On 24.4.12 the sensor was replaced.

7.3. Option ORP calibration

Note The menu CAL ORP is only shown if the ORP measurement is activated and ORP with reference is selected. If you use for ORP a single measuring electrode with the reference of the pH sensor, the calibration menu for ORP is not shown.

7.3.1. Calibration – run ORP

> Select the symbol RUN to start the calibration.

| cal 1/2 | |
|------------------------------|------------------------|
| measure 465 mV 25.0 °C | ORP solution 475 mV |
| start | |

> Put the ORP sensor in ORP solution and press START. Default value is 475 mV. If you want to use another solution, you have to change the calibration settings.

> When the measured value stabilizes, or at the latest after 120 seconds, the process bar is complete, and an OK button appears.

| cal 1/3 | |
|------------------------------|------------------------|
| measure 466 mV 25.0 °C | ORP solution 475 mV |
| OK | |

Note If the measured value is still not quite stable after the 120 seconds, as can be the case with older sensors, wait until it stabilizes, and then press OK.

> With OK you reach the info screen, showing the results of the calibration.

| cal 2/2 | | result |
|---------|--|------------|
| offset | | 9.1 mV |
| date | | 29.09.2011 |
| time | | 12:31:00 |
| discard | | save |

7. Menu cal

- > With the SAVE button you store the results. With DISCARD you reject the results and keep the previous calibration values.

Note **If the offset is not between -100 mV and +100 mV the calibration is not accepted.**

7.3.2. Calibration – offset

If there is a constant difference shown between measuring value and a manually measured value caused by outside influences compensate the difference by an offset.

- > Select ORP CAL in the menu and OFFSET in the submenu.

The screenshot shows a window titled 'cal' with a sub-header 'offset' and an 'ESC' button. The window is divided into two columns. The left column contains the text 'measurement 368 mV' and 'with offset 377 mV'. The right column contains the text 'offset' and a text input field with '9.10' and 'mV' next to it. An 'OK' button is located at the bottom right of the window.

- > Enter the offset as a difference between the manual measurement and the displayed value and confirm with ok.

7.3.3. Calibration – info

The screenshot shows a window titled 'calibration' with a sub-header 'info' and an 'ESC' button. It displays a list of calibration records with columns for date, time, and value.

| date | time | value |
|------------|----------|---------|
| 24.04.2012 | 14:08:56 | 15.0 mV |
| 21.04.2012 | 13:58:32 | 11.4 mV |
| 15.02.2012 | 14:24:38 | 8.9 mV |
| 08.01.2012 | 15:02:16 | 13.9 mV |
| 28.11.2011 | 13:30:01 | 13.2 mV |
| 21.09.2011 | 09:28:36 | 12.8 mV |

If you select the symbol INFO in the submenu CAL, you get a list of the last calibrations. This is helpful with regard to predictive maintenance.

7.3.4. Calibration – settings

If you select SETTINGS in the submenu CAL, you see the current settings for ORP solution and can change it.

The screenshot shows a window titled 'calibration' with a sub-header 'settings' and an 'ESC' button. It contains a text input field with '475' and 'mV' next to it, labeled 'ORP solutions'.

7.4. Option calibrate conductivity

Note **The calibration of a conductivity cell is meant as validation and only during-start-up as adjustment, because a change of the cell constant is usually caused by pollution of the cell. Obviously an adjustment to the current pollution shouldn't be done, the cell should be cleaned instead.**

You can calibrate conductivity and TDS with a reference measurement or a reference solution to determine the cell constant or the TDS factor. Additionally a zeropoint calibration is possible to eliminate possible influences by e.g. cable.

7.4.1. Conductivity calibration – reference

Note You can leave the calibration menu any time with ESC, and with touch screen operation also with the HOME symbol.

- > Select the symbol REFERENCE to start the calibration.

- > If you use a solution with known conductivity take care that the sensor is hanging free and at least the electrodes or for a metal sensor the complete shaft immersed. There should be no gas bubbles at the electrodes and the probe should be complete mixed.
- > If you use a reference measurement for calibration measure the conductivity at the same place where the online measurement is installed. If this is not possible take a representative sample. Keep in mind to use for both measurements the same compensation and reference temperature.
- > Enter the value of the solution or the reference measurement.
- > With OK you execute the calibration and reach the info screen, showing the results of the calibration.

- > With the SAVE button you store the results. With DISCARD you reject the results and keep the previous calibration values.

Note If the c value is not between 0.1 and 20, saving is not possible.

7. Menu cal

7.4.2. Calibration – zeropoint

- > For Zeropoint calibration take the sensor out of the water and wipe it dry. There should be no humidity connection between the electrodes. For plugable connection you can remove the cable from the sensor for zeropoint calibration.
- > In the CAL menu, select ZEROPOINT.

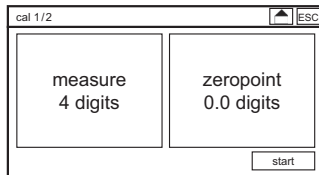

- > With OK you execute the calibration and reach the info screen, showing the results of the calibration.

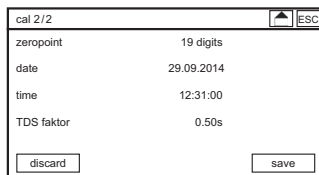

- > With the SAVE button you store the results. With DISCARD you reject the results and keep the previous calibration values.

Note **After zeropoint calibration you have to carry out a reference calibration.**

7.4.3. Calibration – info

| | | | | | |
|-------------|----------|-----------|-----------|------|-----|
| calibration | | | | info | ESC |
| 24.04.2014 | 14:08:56 | 0.50 | 19 digits | | |
| ----- | | | | | |
| 24.04.2014 | 13:58:32 | 0.575 /cm | 19 digits | | |

If you select the symbol INFO in the submenu CAL, you get a list of the last calibrations. This is helpful with regard to predictive maintenance.

7.5. Calibration info

If you select the symbol INFO in the submenu CAL, you get a list of the last calibrations of all measuring parameter. This is helpful with regard to predictive maintenance.

| | | | | | |
|-------------|----------|----------|--------------|------|-----|
| calibration | | | | info | ESC |
| - | - | 58.0 mV | 0.0 mV pH | | |
| - | - | 20.0 mV | 0.0 mV DIS 1 | | |
| - | - | | 0.0 mV ORP | | |
| - | - | 100.0 mV | 0.0 mV DIS 2 | | |
| ----- | | | | | |
| 21.04.2014 | 13:58:32 | 55.0 mV | 0.0 mV pH | | |

8. Digital input

The measuring instrument has 6 digital inputs. You find all settings for the digital inputs in the submenu IN/OUT => DIGITAL.

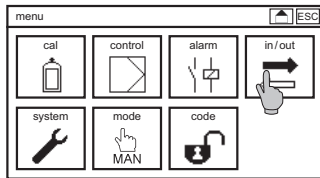

Digital Input 1 to 4

You can define whether the input should work as normally open (NO) or normally closed (NC).

Note Switching of digital inputs 1 and 2 shuts off all controllers.
Switching of digital input 3 shuts off the pH controller.
Switching of digital input 4 shuts off the DIS 1 controller.

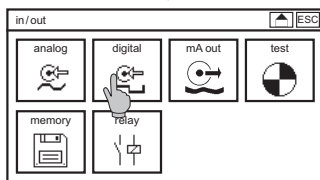

Digital input 5

The digital input 5 is either not active or is used for activation of the second controller parameter set.

Digital input 6 (option third controller parameter set)

Choose in a dropdown list whether the digital input 6 is used as leakage control or for activation of the third controller parameter set.

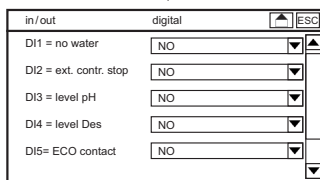

9. Test menu

9. Test menu

The menu TEST is only accessible in the MAN Mode. In all other modes, the symbol is not shown. The test menu always shows a list of the maximum available analog and digital outputs. Naturally, you can operate only those outputs that are activated in your instrument.

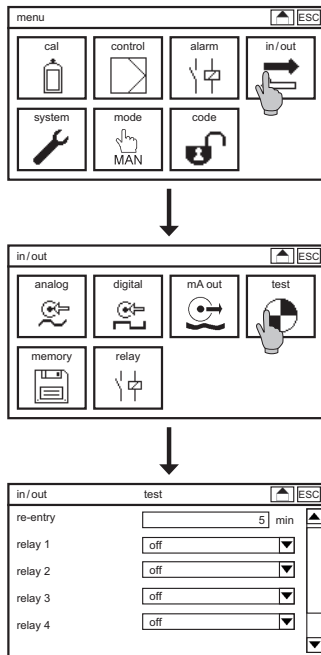

Set the mode to manual. Select the symbol TEST in the submenu IN/OUT.

In the submenu TEST you can switch all available relays and define mA values for the analog outputs. To switch a relay, select ON from its drop-down list. To check an analog output, select its settings to open the keyboard. Set the output to a value between 0.00 and 22.00 mA. This value is then sent out via the selected analog output.

Note When you leave the menu, all relays and all analog outputs are reset to their previous settings.

10. Memory

In the menu MEMORY you can find all functions and settings concerning the SD card.

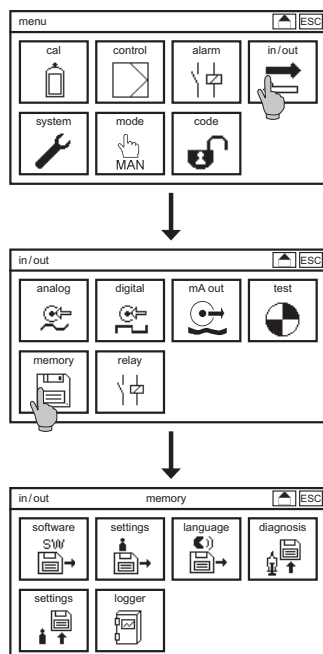

Select the symbol IN/OUT in the main menu, and then in the submenu the symbol MEMORY.

NOTE The submenu logger is shown only if the datalog function has been activated.

10.1. Store and upload settings

You can save all settings on the SD card, for safekeeping, or to duplicate the settings into another instrument of the same type. This way you can easily restore your settings with a new instrument, or after a software-update, or after adding additional functions. With an appropriate PC program, you can even do all settings on the PC and then load them into the Neon® instrument via SD card.

10. Memory

10.1.1. How to save settings

Make sure that an industry-standard SD card (max. 2 GB) with free storage space is plugged into the instrument.

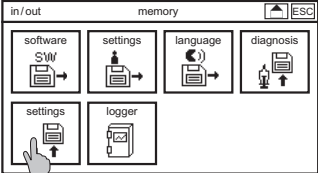

In the menu IN/OUT => MEMORY select the symbol SAVE SETTINGS.

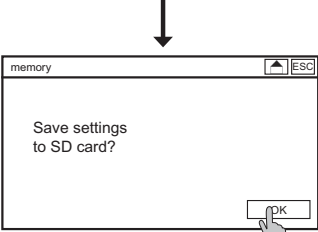

Acknowledge with OK.

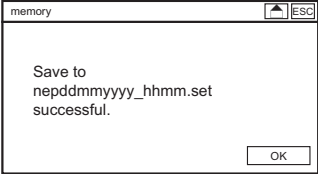

The display shows the name of the created file. The name consists of the parameter and the date. Acknowledge with OK.

10.1.2. How to load settings

Make sure that the SD card with the settings-file is plugged into the instrument.

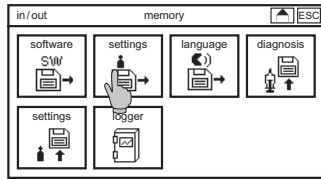

In the submenu MEMORY select the symbol LOAD SETTINGS.

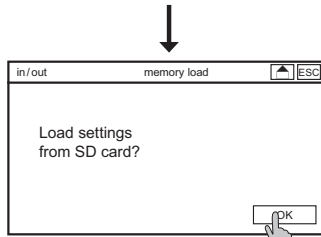

Acknowledge with OK.

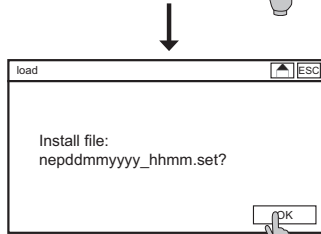

The display shows the name of the file that will be loaded. The name consists of the parameter and the date. Acknowledge with OK.

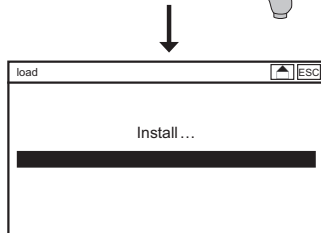

Progress is indicated by a status bar.

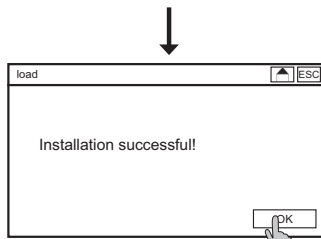

Acknowledge with OK.

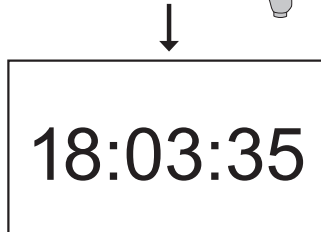

After installation, the instrument initializes. During that process, the time is displayed on the desktop

10. Memory

10.2. Software update

For a software-update we will send you two files. Save both files on an industry-standard SD card – directly, use no subfolder! Plug the SD card into the instrument.

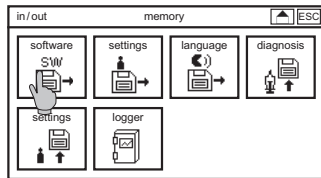

In the submenu MEMORY select the symbol LOAD SOFTWARE.

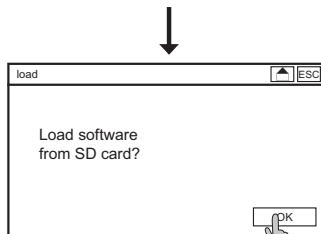

Acknowledge with OK.

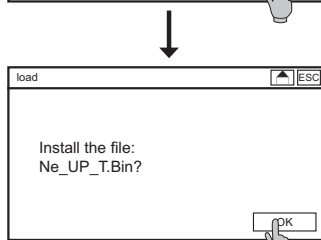

The display shows the name of the file that will be loaded. Acknowledge with OK.

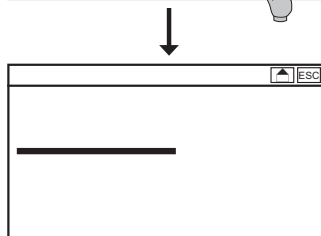

Progress is indicated by a status bar.

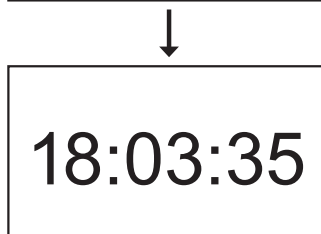

After installation, the instrument initializes. During that process, the time is displayed on the desktop.

10.3. Load languages

Various menu languages are available: German, English, Spanish, Danish, Dutch, French, Polish, Russian.

You can load up to further languages. Create a language file with our help (name.ptf). Save the file directly without subfolder on the SD card. Put the SD card into the instrument.

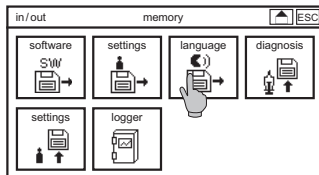

Select the symbol LANGUAGE in the submenu MEMORY.

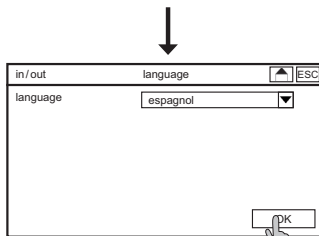

Select the chosen language in the dropdown list and confirm with OK.

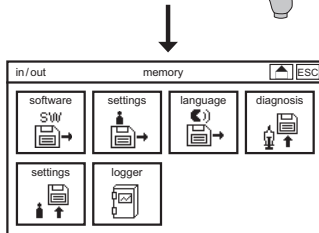

The instrument returns to menu memory. To choose the loaded language select the menu SYSTEM => LANGUAGE.

10. Memory

10.4. How to save the diagnosis file

If the measurement does not run as planned, it is useful to assess the situation by checking all settings and current values. To collect all the information and maybe have it ready for a contact person, you can save a diagnosis file on the SD card.

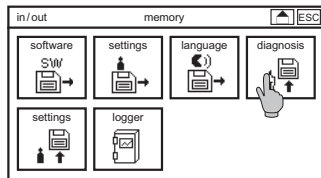

In the submenu MEMORY select the symbol SAVE DIAGNOSIS.

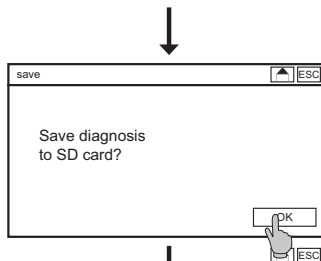

Acknowledge with OK.

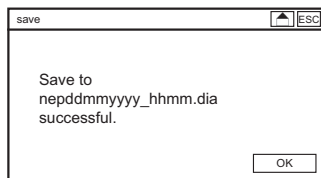

The display shows the name of the created file. The name consists of the parameter and the date. Acknowledge with OK.

Note The .dia file is a binary file and can only be read with an appropriate configuration program.

11. System functions

Note System settings can only be changed with the full access code.

11.1. Language

Various menu languages are available: German, English, Spanish, Danish, Dutch, French, Polish, Russian.

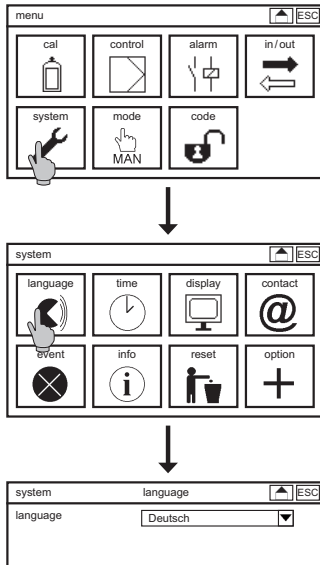

To change the language, select the symbol SYSTEM in the main menu and in the submenu the symbol LANGUAGE. A drop-down list shows all languages that are available on your instrument.

Note You can extend the choice of languages by loading new languages in the instrument via the menu MEMORY.

11.2. Time

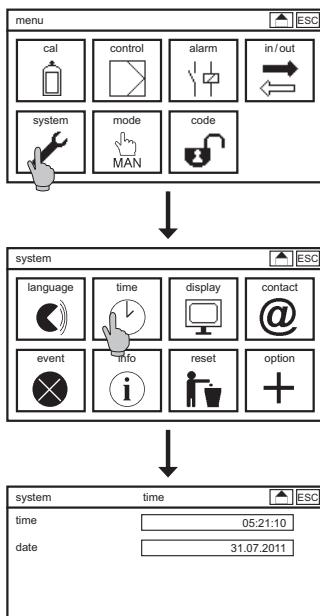

To set the internal clock, select the symbol SYSTEM in the main menu, and in the submenu the symbol TIME.

When you select the field of either time or date, a keyboard appears to enter the desired time or date. For your convenience, the instrument adds zeros automatically. If you enter 6, for example, the time will be set to 06:00:00.

11. System functions

11.3. Display

All settings concerning the display are found in the submenu SYSTEM => DISPLAY.

11.3.1. Settings

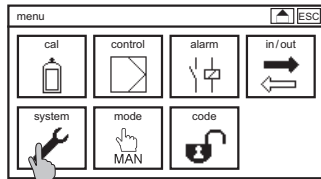

Contrast

With CONTRAST you can adjust the brightness of the display, between 0% and 100%.

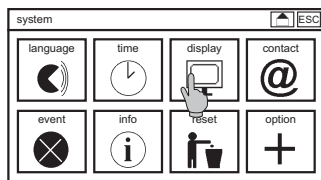

Desktop

This submenu contains a drop-down list of various desktop designs. The selection is activated as soon as you leave the menu.

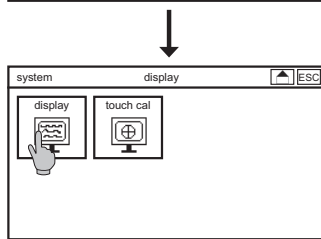

You can switch the display design by touching the instrument name on the desktop. To ensure that this selection is permanent, set the display design in the DESKTOP submenu to -----. Otherwise the design will be reset to the one specified in this menu whenever you enter any menu.

Selection : -----

If you select the line (-----), the desktop remains in its previous design.

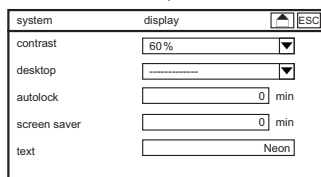

Note Text, time, the triangle, and the event messages are part of all desktop designs.

Selection: default

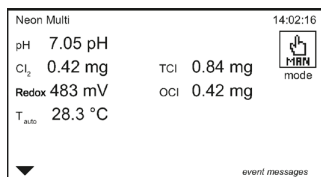

The default design shows the measured values and the temperature.

Selection: SD card

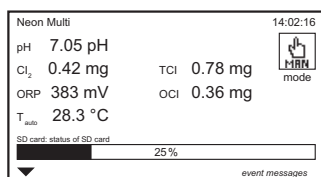

This adds a status bar indicating the remaining storage space on the SD card.

Selection: Contact

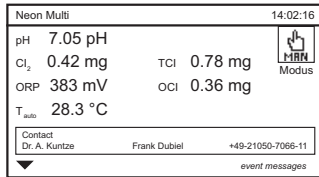

This adds the contact data that is stored in the submenu SYSTEM => CONTACT.

Selection: Relays (add-on controller)

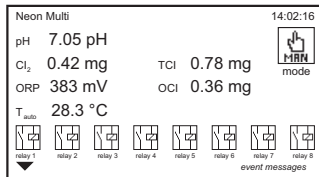

This adds the status of all relays and the mode. Active relays are shown white on black, and the symbols show whether the relay is open or closed.

Autolock

The autolock function ensures that an invalid code is set after an adjustable interval without operation, even if you have forgotten to change the code manually before leaving the instrument. Autolock sets the code back to 0000, and the display shows the desktop with the measured values. If you set the interval to 0, the autolock function is deactivated.

Screen saver

Screen saver turns off the display illumination after an adjustable interval. If you set the interval to 0, screen saver is deactivated, and the illumination remains on permanently.

Note **The screen saver not only saves energy, it also extends the life span of the display.**

Text

Here you can enter an identification or location, which will be shown on the left side of the top line of the desktop.

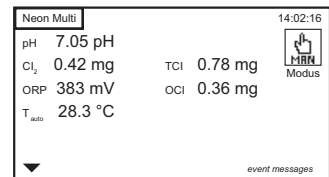

11. System functions

11.3.2. Touch Cal

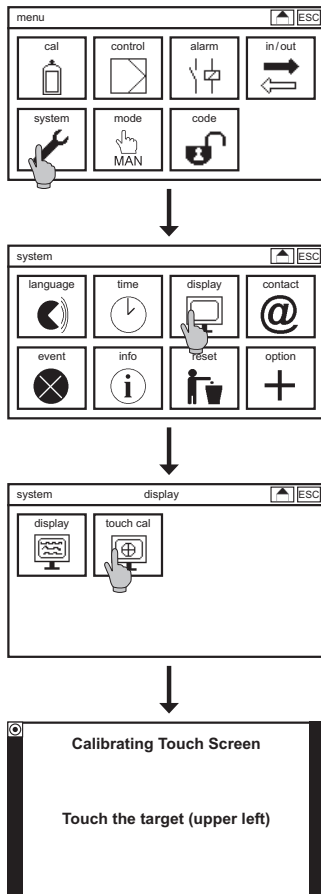

To calibrate the touch screen, select in submenu SYSTEM=>DISPLAY the symbol TOUCH CAL to start the calibration. The touch screen calibration texts are available in English only.

Note When started, the calibration routine cannot be left until it is finished, it has to be carried out completely.

The routine comprises four steps. You have to touch each corner of the display, and finally the center of the display.

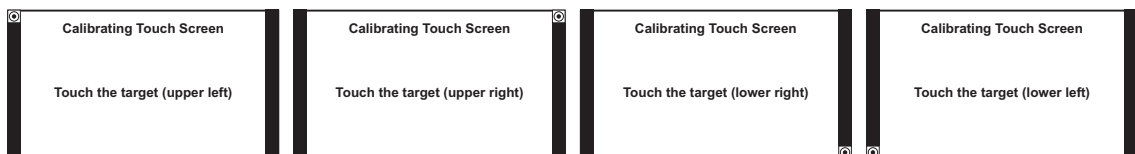

Note The touch screen calibration can also be started by touching the screen for more than 30 seconds.

11.4. Contact

In the submenu SYSTEM => CONTACT you can store contact data of your contact person, including company name, personal name, and phone number.

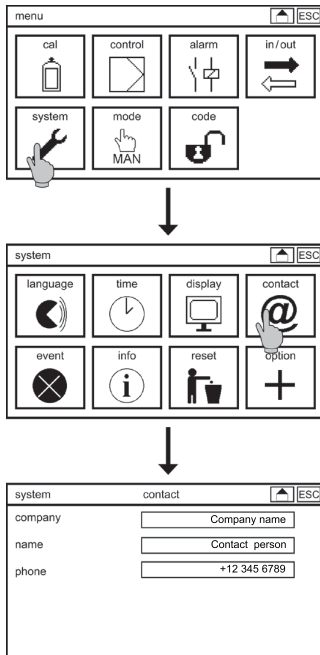

Select in the submenu SYSTEM the symbol CONTACT. For each field a keyboard opens to enter the name or number.

Note Contact data can be shown on the desktop, if you select the display design "Contact".

Note With restricted access (Code 0202) you can view this menu but not change the settings.

11. System functions

11.5. Event-related support

If an event message appears on the desktop, the submenu SYSTEM => EVENT provides information on the event and suggestions how to solve it.

Select in the submenu SYSTEM the symbol EVENT. You can reach this submenu directly by touching the event message on the desktop. If there are no event messages, the event help will only show "no active event". If more than one event is currently indicated, you can scroll up and down to view all events.

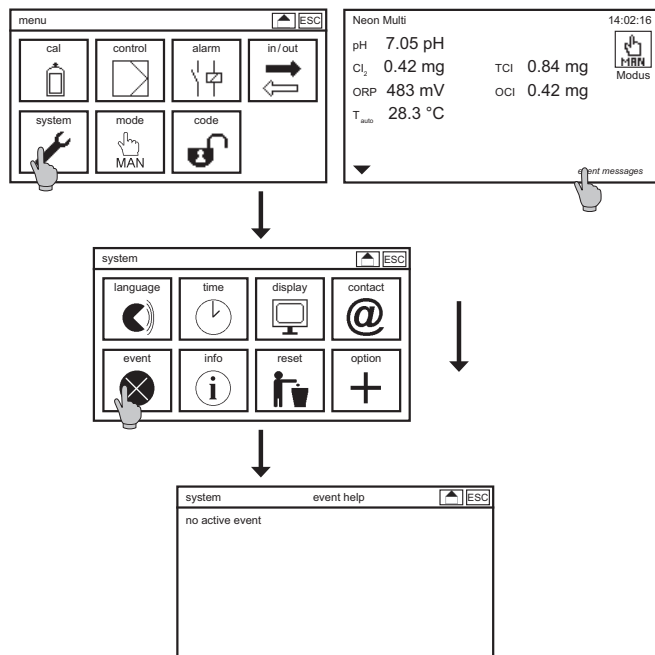

11.6. Info

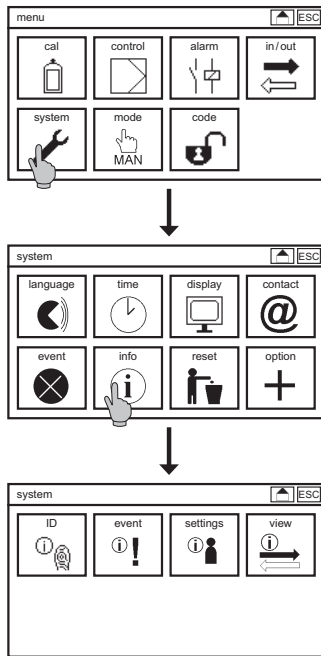

The submenu INFO is found in the submenu SYSTEM. It contains four symbols:

ID

This shows the serial number, the software version, and the operating hours of the instrument, followed by a binary display of the activated add-ons.

Eventlog

The event log stores up to 100 events, with the time they appear (*) or leave (#).

Settings

This submenu shows a complete list of all settings. Press UP and DOWN to view the complete list.

View

This submenu shows the raw signals of the sensors, the output signals of the mA outputs, and the status of the digital inputs.

Note

The analog outputs are add-ons, and are shown only if the instrument is equipped with these features.

11. System functions

11.7. Restore factory setting or start configuration

Note The option „start configuration“ appears only if such configuration has previously been defined on the expert level.

The reset resets all settings to factory settings or start configuration, except the time, date, contact and the measuring parameter and range for disinfectants measurement. Activated add-ons will remain activated, of course.

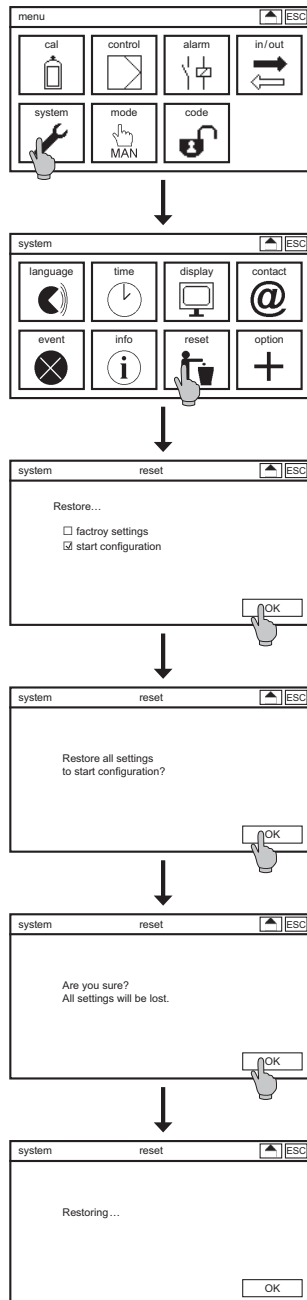

Select the symbol SYSTEM in the main menu, and in the submenu the symbol RESET.

Select factory settings or start configuration and acknowledge with OK.

Acknowledge with OK

Acknowledge with OK

All settings are reset, and the instrument initializes.

11.8. Add-on activation

In this menu you can activate add-ons. Enter the 6-character code you have received with the purchase to add one or more of the following features:

- > ORP measurement
- > Conductivity measurement
- > Second Free/Total Chlorine measurement
- > 5 analog outputs
- > Automatic sensor cleaning ASR®
- > Data logger with trend view
- > Modbus RTU (RS 485) – needs additional hardware

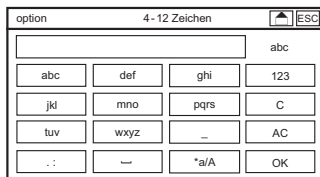
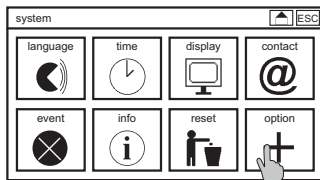
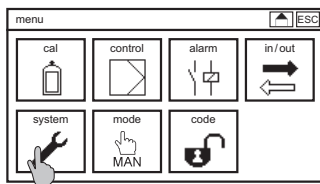

To activate add-ons, select the symbol SYSTEM in the main menu, and in the submenu the symbol ADD-ON.

A keyboard appears to enter the code.

Note **The input is case-sensitive! Observe capital and small letters.**

After a successful activation, the display shows which features have been activated, and the instrument initializes. If the entered code was incorrect, no message appears, and the previous settings are maintained.

Note **We recommend to reset all settings or start configuration to factory settings after activating add-ons.**

12. Expert menu

12. Expert menu

Set the code to 1818 and the menu EXPERT is shown.

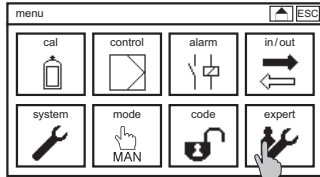

Select the symbol EXPERT in the menu.

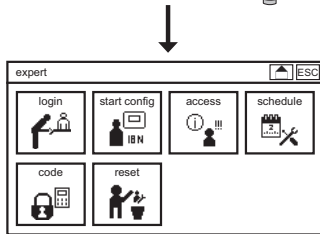

12.1. Login and access

You can log in in the menu LOGIN and thus have an overview in the menu ACCESS of all changes since your last log in.

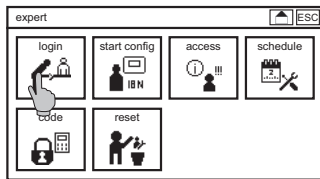

Select in the submenu EXPERT the symbol LOGIN.

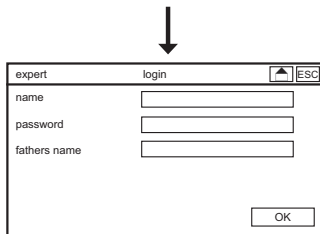

Put in your user name and password and at the first log in your fathers name as security query. Acknowledge with OK.

12.2. Start configuration

You can store the current settings as start configuration in the menu EXPERT. The user can load the start configuration in the menu SYSTEM => RESET.

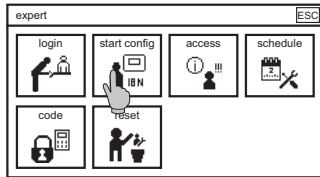

Select in the submenu EXPERT the symbol START CONFIG .

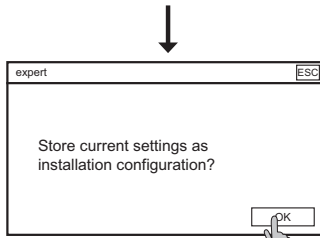

Acknowledge with OK.

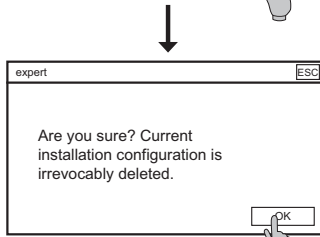

Acknowledge with OK.

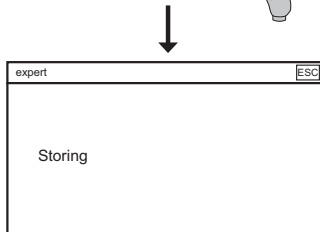

Start configuration will be stored.

12. Expert menu

12.3. Schedule

You can store a maintenance schedule for calibration, cleaning and changing wear parts in the menu EXPERT. Select in the submenu EXPERT the symbol START CONF.

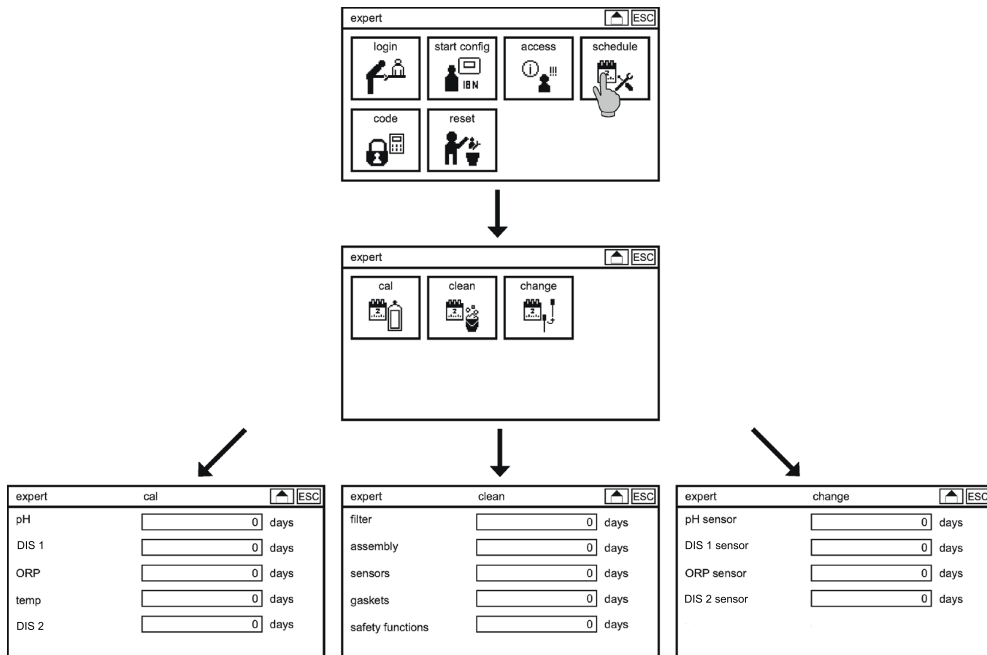

You can select an interval for each menu parameter. In this interval the maintenance message occurs. The message is shown until the user acknowledges.

12.4. Code

In menu EXPERT you can put in individual user codes for the different access levels.

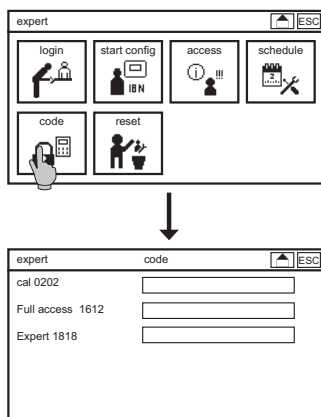

Select in the submenu EXPERT the symbol CODE.

Enter your individual user codes for the different access levels.

Note

The preset user codes are deactivated by entering the new codes. After a reset in the menu SYSTEM => RESET the individual user codes are still valid. After a reset in the menu EXPERT=>RESET all settings are deleted including the expert menu.

12.5. Reset

In the menu RESET you have the possibility to set all settings to factory settings including the expert menu.

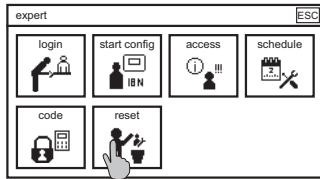

Select in the submenu EXPERT the symbol RESET.

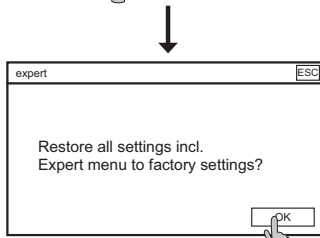

Acknowledge with OK.

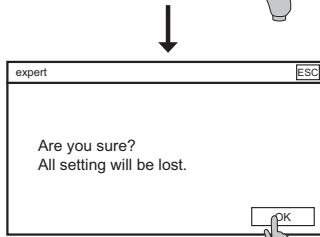

Acknowledge with OK.

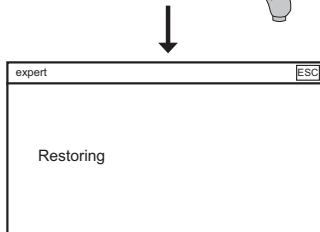

All settings are reset, and the instrument initializes.

13. Alarm relay

13. Alarm relay

13.1. Settings

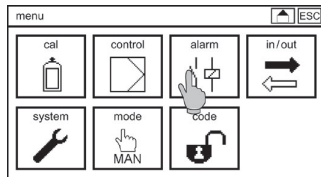

Select the symbol ALARM in the main menu.

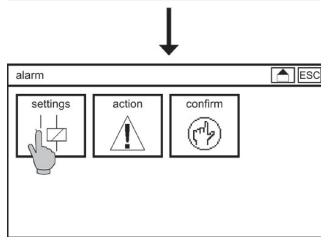

In the submenu, select the symbol SETTINGS.

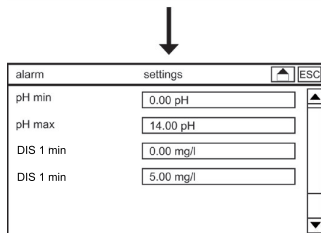

Here you can set the following parameters:

Delay

This defines a delay time – in case of an event, the alarm relay switches only after a specified interval. Display of the text message on the desktop and output of 22 mA error current are not affected by this setting and will occur immediately.

Lower limit/upper limit

For each parameter you can define an upper and a lower limit. If the measured value is higher than the upper limit or lower than the lower limit, an alarm is issued via the alarm relay– if you have specified the limits as alarm actions.

13.2. Alarm action

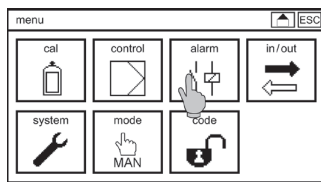

Select the symbol ALARM in the main menu.

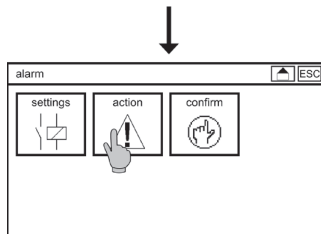

Select the symbol ACTION.

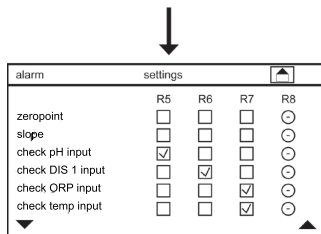

A list of all possible actions appears.

By activating the check boxes you can define which event should cause the alarm relays 5, 6, 7 or 8 to switch. An empty box means that the actions or event does not cause the relay to switch.

Note

If an action concerns an add-on that you have not activated, the box cannot be selected. The same is true for relays which are blocked with other functions.

13. Alarm relay

13.3. Alarm confirmation

Events will be readout as alarm as long as they are active. If you choose confirmation they are shown until a user acknowledges them.

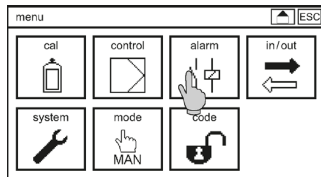

Select in the menu the symbol ALARM.

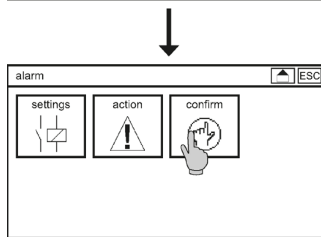

Select in the submenu the symbol CONFIRM.

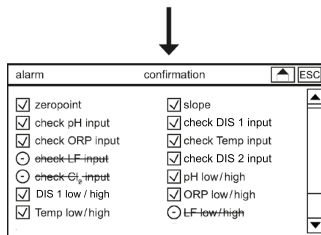

The confirmation list is shown.

By ticking the box you select which events need to be confirmed by the user. An unticked box means that there is no need to confirm the event. The readout via alarm relays or the display alarm queue is not affected by the choice.

Note Only events of activated addons are selectable. All others are shown crossed out.

If an event chosen for confirmation occurs, a popup is shown until the user acknowledges with OK.



Note The event itself and all resulting alarm outputs via relay are active until the event is gone – regardless of the confirmation.

14. Controller

Neon® Multi offers a concentration-based controller with 4 control relays.

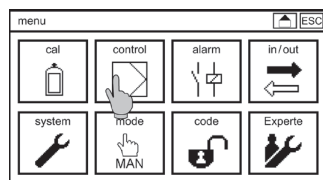

In the main menu select the symbol CONTROL. In the CONTROL menu you find the following submenus: pH, DIS 1, and optionally EC or DIS 2, in which you define parameters for control and output.

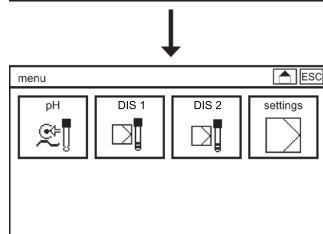

In the sub menu SETTINGS you can activate a second parameter set and define a start delay and dosage check time.

14.1. Assignment of control relays

Note The control relays are assigned to the control variables depending of the menu settings. The relays are not freely assignable.

| Parameter | setting | relay 1 | relay 2 | relay 3 | relay 4 |
|-----------|---|-------------------------------|-----------------|----------------------------------|--------------------|
| pH | Actuator Cl Actuator | S1 pH open | S1 pH close | | |
| | Dosing pump Pulse pump On/off | S1 pH (raise or reduce) | | | |
| | 2 dosing pumps 2 pulsepumps 2 on/off | S1 pH raise | S2 pH reduce | | |
| DIS 1 | Actuator Cl Actuator | | | S1 DIS 1 open | S1 DIS 1 close |
| | Dosing pump Pulse pump On/off | | | S1 DIS 1 (raise or reduce) | |
| | 2 dosing pumps 2 pulsepumps 2 on/off | | | S1 DIS 1 raise | S2 DIS 1 reduce |

14. Controller

| Parameter | setting | relay 1 | relay 2 | relay 3 | relay 4 |
|--------------------------|-------------|---------|----------------------|---------|----------------------|
| Conductivity or DIS 2 | Dosing pump | | S1 EC/DIS 2 | | S1 EC/DIS 2 |
| | Pulse pump | | (raise or reduce) | | (raise or reduce) |
| | On/off | | | | |

14.2. Configuration controller – standard parameter set

Select in the submenu CONTROL the parameter for example pH. If the second parameter set is activated choose STANDARD to make the following settings:

Setpoint

Define which value the measured value should reach.

Type

Select between on/off, 2 on/off, pulsepump, 2 pulsepumps, dosing pump, 2 dosing pumps, actuator cl and actuator. The setting 2 is necessary if you have connected two pumps to raise and reduce the value via the controller.

The ON/OFF controller doses with 100% until the measured value reaches the set point, and then stops.

For all other controller types you can configure up to PID and define the output as pulse-pause or pulse frequency. With PULSPUMP the control variable is given out via switching frequency of the relay (pulse-frequency controller) and with DOSING PUMP via time frames in which the relay is on (pulse) and off (pause) in relation to the controller output.

ACTUATOR CL is used for actuator with position feedback and ACTUATOR is used for actuators without position feedback.

Type selection changes the menu. Only parameters which are suitable to the selected controller are shown.

Direction

With this setting you define whether dosing occurs above or below the set point.

Select RAISE if the dosing increases the measured value. The controller doses whenever the measured value is lower than the set point.

Select REDUCE if the dosing decreases the measured value. The controller doses whenever the measured value is higher than the set point.

Note **Direction is only selectable for single controller types. For 2 controller type the direction is fixed.**

14.2.1. Priority pH-controller

| | | |
|---------------|-------------|-------|
| control | standard | [ESC] |
| type | dosing pump | |
| setpoint | 0.00 | mg/l |
| direction | raise | |
| pH priority | on | |
| pH hysteresis | 1.0 | pH |

If you have set DIS 1 to Chlorine, you can activate priority for the pH-controller, and set a hysteresis. When activated, the Chlorine controller starts only when the pH value has reached „set point +/- half hysteresis“. This accounts for the pH influence on the Chlorine measurement and prevents overdosing at high pH values.

14.2.2. On/off/2 on/off – controller

| | | |
|------------|----------|-------|
| controller | standard | [ESC] |
| type | on/off | |
| setpoint | 7.00 | pH |
| hysteresis | 0.00 | pH |
| direction | raise | |

Besides set point and controller type you can set the following parameter:

Hysteresis

For the on/off controller you can define a hysteresis. This prevents constant switching of the relays in the vicinity of the set point – the relay switches only when the difference between set point and measured value exceeds half the hysteresis value.

14.2.3. P / PI / PID controller

Note

Define the control function by setting the values for p-range, integral time and differential time. If you for example set no value for p-range, integral time and differential time the controller works as an on/off controller. If you set a p-range the controller works as P controller, if you additionally set an integral time the controller works as PI controller.

14.2.3.1. P controller

The P controller reduces the dosing when the difference between set point and measured value is smaller than the specified P range. Within the p range, the controller output is proportional to the remaining deviation. When the measured value reaches the set point, dosing stops.

P range

The P range or proportional range is the range in which dosing is reduced proportional to the deviation between set point and measured value. The bigger the P range, the softer the control.

To find the ideal setting, start with a big P range and reduce it until the measured value oscillates around the set point in a stable manner. Double this value to get the ideal value. If the measured value still oscillates, use a slightly higher value.

14.2.3.2. PI controller

The PI controller is a P controller with additional I function. The I function sums up the previous dosing, so that the controller output drops to zero only after the measured value already exceeds the set point. This eliminates in applications with constant inflow the otherwise unavoidable control deviation.

14. Controller

P range

For settings and information refer to P controller.

Integral time

The shorter the integral time, the stronger the I function.

Start by setting a P controller, then reduce the proportional range until the measured value fluctuates constantly around the set point. Measure the time between subsequent maximum measured values. The ideal P range is then 2.2 times the current setting and the ideal integral time is 0.85 times the measured time between maximum values. If the measured value still oscillates set slightly higher values.

14.2.3.3. PID controller

The PID controller is a PI controller with additional D function. The D function acts swifter and compensates the inertia of the I function. This allows the controller to react faster to large control deviations.

P range

For settings and information refer to P controller.

Integral time

For settings and information refer to PI controller.

Differential time

The higher the differential time, the stronger the D function.

Start by setting a P controller, then reduce the proportional range until the measured value fluctuates constantly around the set point. Measure the time between subsequent maximum measured values. The ideal P range is then 1.66 times the current setting, the ideal integral time is 0.5 times and the ideal differential time 0.12 times the measured time between maximum values. If the measured value still oscillates set slightly higher values for P and I and slightly lower values for D.

14.2.4. Pulsepump/2 pulsepumps

| | | |
|---------------|----------|-----|
| controller | standard | ESC |
| type | pulspump | |
| setpoint | 7.00 | pH |
| direction | raise | |
| P range | 0.00 | pH |
| integral time | 0 | sek |
| | | |

Besides set point, controller type, direction, p-range, integral time and differential time you can set the following parameter:

Pulsfrequenz

Enter the frequency that corresponds to maximum dosing.

| | | |
|-------------------|----------|-----|
| controller | standard | ESC |
| direction | raise | |
| P range | 0.00 | pH |
| integral time | 0 | sek |
| differential time | 0 | sek |
| Pulsfrequenz | 2 | mpH |

14.2.5. dosing pump / 2 dosing pumps

| | | |
|---------------|-------------|-----|
| controller | standard | ESC |
| type | dosing pump | |
| setpoint | 7.00 | pH |
| direction | raise | |
| P range | 0.00 | pH |
| integral time | 0 | sek |

Besides set point, controller type, direction, p-range, integral time and differential time you can set the following parameters:

Pulse min

Define a minimum pulse, i.e. the minimum time the relay has to be on to allow the actuator to react.

| | | |
|-------------------|----------|-----|
| controller | standard | ESC |
| P range | 0.00 | pH |
| integral time | 0 | sek |
| differential time | 0 | sek |
| pulse min | 0.2 | sek |
| pulse pause | 10 | sek |

Puls-Pause

For a pulse-pause controller define as Pulse-Pause time a time-frame in which the relay is on (pulse) and off (pause) according to the control variable.

14.2.6. Actuator CI

| | | |
|--------------------|-------------|-----|
| controller | standard | ESC |
| type | actuator ci | |
| calibrate actuator | | |
| setpoint | 7.00 | pH |
| hysteresis | 6.00 | pH |
| direction | reduce | |

Besides set point, controller type, direction, p-range, integral time and differential time you can calibrate the actuator:

Press REDUCE to move the actuator to the 0% position. Please make sure the valve is fully closed. Press the 0% button to save the motor position. Press RAISE to move the actuator to the 100% open position. Press the 100%-button to save the motor position. When you have saved the correct values press OK to exit the calibration menu.

| | | | |
|-------|--------|------|------|
| raise | reduce | 0% | 0 |
| | | 100% | 4095 |
| OK | | | |

14.2.7. Actuator

| | | |
|------------|----------|-----|
| controller | standard | ESC |
| type | actuator | |
| setpoint | 7.00 | pH |
| Hysteresis | 0.00 | pH |
| direction | raise | |
| P range | 0.00 | pH |

Besides set point, controller type, direction, p-range, integral time and differential time you can set the following parameters:

Pulse min

Define a minimum pulse, i. e. how long the relay has to be ON to allow the actuator to react.

| | | |
|-------------------|----------|-----|
| controller | standard | ESC |
| P range | 0.00 | pH |
| integral time | 0 | sek |
| differential time | 0 | sek |
| pulse min | 0.2 | sek |
| motor run time | 100 | sek |

Motor run time

To control a motor-operated valve, the instrument needs to know how long it takes the motor to completely open the valve when it had been completely closed. Determine that time by closing the valve completely and then opening it in manual operation, or vice versa. This time is the motor run time.

14.3. Configuration controller – second parameter set

Settings

Select the menu CONTROL and then the submenu SETTINGS. Here you can set the following parameters:

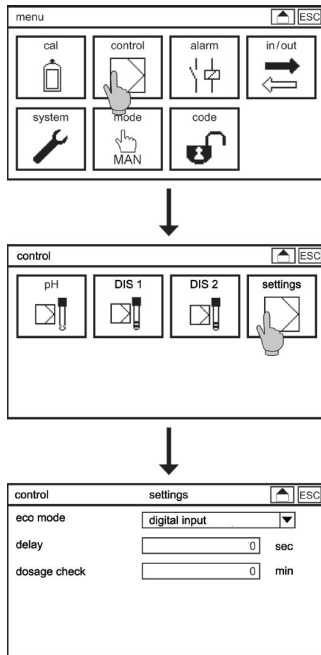

With **ECO-MODE** you enable the second parameter set.

Select **DIGITAL INPUT** if the second parameter set should be activated via digital input 5.

Select **DIN VALUES** if the second parameter set should be activated when the measured values lie within the following tolerances (hysteresis for all values 0.03):

- > Cl₂ 0.3.. 0.6 mg/l
- > pH 6.5.. 7.5
- > ORP > 750 mV
- > organic Chlorine < 0.2 mg/l

Select **DIN** and **DI** if the second parameter set should be activated both ways.

Note When you turn on **ECO MODE**, the instrument asks whether you want to copy the standard settings. If not, factory settings are used as start configuration.

Delay

The delay is the time that has to pass after a controller stop before dosing starts. A controller stop happens when the power is cut off or as a result of certain events, for example the switching of a digital input. At the end of this chapter you will find a list of these events.

Note Changing the operation mode does not activate the start delay.

Dosage check

With the parameter dosage check you define how long the instrument may dose with 100% feed rate without raising alarm. If after that time the measured value still has not reached the set point or at least the P range, so that the controller output is still 100%, an alarm is issued and the controller is stopped. This is a safety measure to prevent the release of hazardous chemicals in case of damaged feed lines – if the dosing does not seem to have any effect, the reason might be that there is a leak somewhere and the chemicals do not reach the water.

Note In the event of a dosage alarm, only the concerned controller is switched off.

Note If you set the time to 0 min, the function is deactivated for the corresponding controller.

14.4. Activating and deactivating the controller

To activate or deactivate the controller you have to change the operation mode. You can change the mode in the main menu by pressing the symbol MODE. The symbol changes its design according to the selected mode.

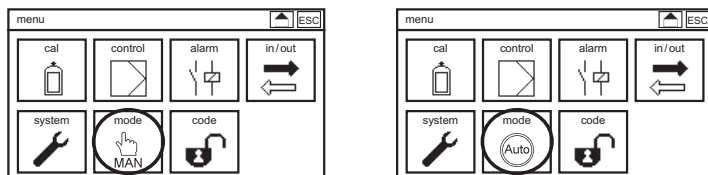

In the AUTO mode the controller is active and operates the relays and/or current outputs and ultimately the connected actuators. Manual operation of the relays and current outputs via the test function is not possible.

In the manual mode (MAN) the controller is deactivated and you can operate the relays and current outputs manually via the test function.

In the maintenance mode – HOLD – the controller is deactivated.

Note More information on the operation modes can be found in chapter 5 – Mode.

14.5. Relay display and manual operation of the control relays

For control applications, we advise to use the desktop design “Relay” in the menu SYSTEM.

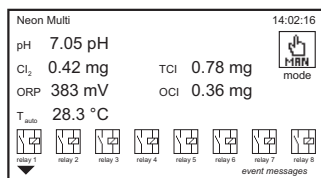

Below the measured values the configuration and status of the relays are displayed, and a button appears with which you can change the operation mode.

Note More information on the various display designs can be found in chapter 12 – system functions.

In the manual mode you can operate the control relays manually. By pressing the symbol of a relay to switch it.

Warning Manually activated relays remain activated until they are manually switched off or the operation mode is set to automatic!

14.6. Automatic controller stop

The instrument provides various safety measures to recognize problems and to stop the dosing if no reliable measured values are available. Such situation occurs in case of the following events:

14. Controller

- > If the measuring input or the temperature input receives no signal (no measured value available)
- > If digital input 1 or 2 switches all controller are stopped
- > Switching of digitale input 3 stops the pH controller and switching of digital input 4 stops the DIS 1 controller
- > Dosage check (possible damage on the feed lines)

It is your responsibility to ensure through set-up and settings that all these safety features can work as planned and to check their proper function through regular tests! Also use the safety features that are not controller-related, such as the alarm relay, the limits, and the 22 mA alarm current.

Warning

In the AUTO mode the controller actuates the dosing of possibly hazardous chemicals! Check all connections, feed lines, and all settings before you activate the controller, and make sure that the control works properly before leaving the instrument!

15. Relay

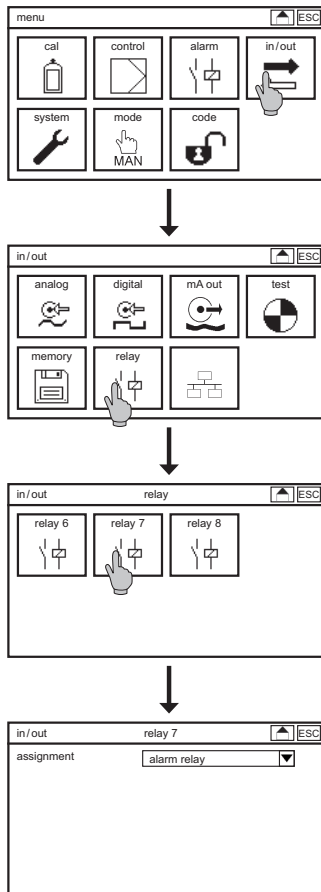

Select in the menu IN/OUT the symbol RELAY. In the submenu you can define for relays 6, 7 and 8 whether they work as alarm relays or have different functions.

Note Relay 6 and relay 8 are only shown if the coagulation dosing or the third digital input is activated as an option.

Relay 7

If you define relay 7 as an alarm relay, you can assign it to the events in the menu ALARM => ACTION.

If you define relay 7 as circulation, the relay switches if the second parameter set is activated by digital input 5 or the DIN values.

Note Relay 7 is only shown if the Eco mode is set in the menu CONTROL => SETTINGS to DI, DIN or DI and DIN.

16. Add-on Datalog

Note The symbol logger is shown only if the add-on datalog has been activated.

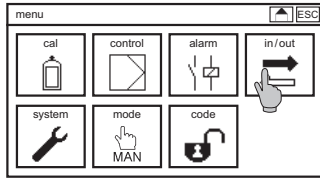

Select the symbol IN/OUT in the main menu, and in the submenu the symbol MEMORY.

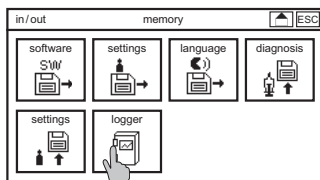
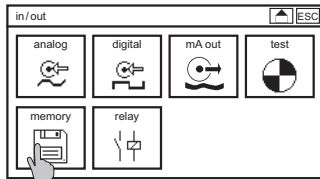

If the datalogger option is activated, sixth symbols appear. Select the symbol LOGGER.

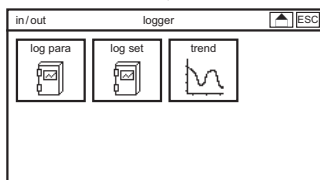

In the menu LOG PARA you decide which parameters are logged, in LOG SETTINGS you define interval and log mode and view the status. In TREND you can see a graphical display of the measured values over the last 2h, 24h or 72h.

Log para

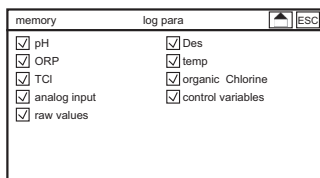

You decide which parameters are logged. Tick the boxes to log the parameter.

Log set

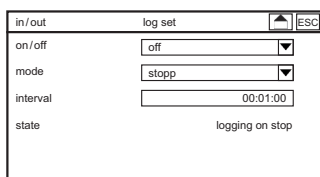

In the submenu LOG SET you can make the following settings:

On/off

You can start or stop the data logger in this menu.

Note **Never remove the SD card while the logging is running! Always set the mode to OFF (not stop!) before removing the card. Otherwise data loss might occur, and an error message will appear.**

Modus

You determine the storage mode by setting it either to stop or ring. Stop means that the logging stops when the card is full. Ring means that when the card is full, the oldest data will be overwritten.

Note **FAT16 by Microsoft limits the number of files in the root folder to 512. Therefore we advise to keep the number of files in the root folder small and to move older files into subfolders to avoid storage problems.**

Interval

The INTERVAL defines the time between subsequent datalogs. You can enter an interval of 1 second up to 24 hours.

Example:

00:00:01 means that each second the values are logged.

00:01:00 means that each minute the values are logged.

01:00:00 means that once every hour the values are logged.

Note **The instrument fills in zeros automatically.**
Example: 1 is interpreted as 00:00:01 / 1: is interpreted as 00:01:00 / 1:1: is interpreted as 01:01:00

16. Add-on Datalog

16.1. View logged data

To remove the SD card, first set mode to OFF, then press the SD card to take it out of the instrument.

Note If you remove the card without deactivating the logger, data loss might occur, and the instrument displays an error message.

```
1 Text: Neon ;
2 Device SnNr: He00001J01 ;
3 Device SW: V 2.18 ;
4 Modul SnNr: 00103;
5 Modul SW: V 02.00;
6
7
8 Mode: [Stop]
9
10 Interval: 1 sec
11
12
13 Date: Time: Measure-Value[pH]; mV-Value[mV]; Temperatur[°C]:
14
15 14.09.2013:12:03:36:+6,99; +0; +25,0;
16 14.09.2013:12:03:37:+6,99; +0; +25,0;
17 14.09.2013:12:03:38:+6,99; +0; +25,0;
18 14.09.2013:12:03:39:+6,99; +0; +25,0;
19 14.09.2013:12:03:40:+6,99; +0; +25,0;
20 14.09.2013:12:03:41:+6,99; +0; +25,0;
21 14.09.2013:12:03:42:+6,99; +1; +25,0;
22 14.09.2013:12:03:43:+6,99; +1; +25,0;
23 14.09.2013:12:03:44:+6,99; +0; +25,0;
24 14.09.2013:12:03:45:+6,99; +0; +25,0;
25 14.09.2013:12:03:46:+6,99; +0; +25,0;
26 14.09.2013:12:03:47:+6,99; +0; +25,0;
27 14.09.2013:12:03:48:+6,99; +0; +25,0;
28 14.09.2013:12:03:49:+6,99; +0; +25,0;
29 14.09.2013:12:03:50:+6,99; +0; +25,0;
30 14.09.2013:12:03:51:+6,99; +0; +25,0;
31 14.09.2013:12:03:52:+6,99; +0; +25,0;
32 14.09.2013:12:03:53:+6,99; +0; +25,0;
33 14.09.2013:12:03:54:+6,99; +0; +25,0;
34 14.09.2013:12:03:55:+6,99; +0; +25,0;
```

Logged data are stored in CSV files. The file name consists of the measuring parameter, the date, and the time. Each file starts with the device name, the instrument number, and the software versions, followed by the log mode and the interval. Measured values are listed line by line, separated by semicolons.

CSV files can be opened with commercially available spreadsheet software such as OpenOffice Calc or Microsoft Excel or in a simple text program.

For each day, a new file is created. Additionally, a new file is created if:

- > Power was turned off
- > The logging was stopped and restarted
- > Other parameters for the datalogging were selected

17. Add-on mA output

As soon as the mA outputs have been activated, the symbol mA OUT appears in the submenu IN/OUT.

Here you can set the following parameters:

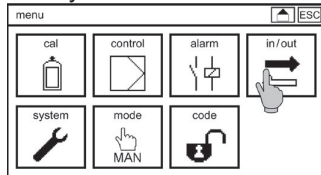

Assignment

Select which parameter you want to read out via the mA output: pH, DIS 1, optionally ORP, conductivity, DIS 2, or control variables.

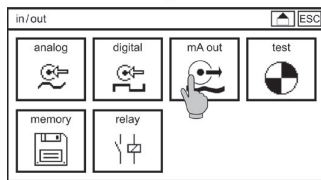

Range

Select either 0-20 mA or 4-20 mA from the drop-down list.

Note

While 4-20 mA gives slightly less resolution, it helps identifying cable breaks.

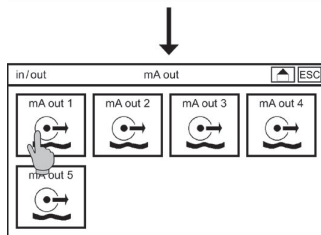

Note

At works, the mA outputs are set to “not used” since they are equipped with a load monitor. If you assign a parameter to a mA output while the output is unconnected or the connection is interrupted somewhere, the event message “load impedance mA” appears in the display.

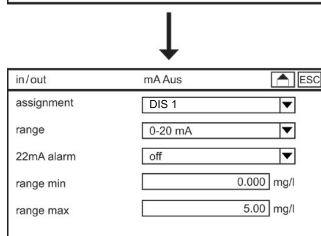

22 mA alarm

If you activate this function, the mA output rises to 22 mA whenever the measuring inputs received no proper signals.

Range min and max

You can zoom by defining which measured values correspond to 0/4 mA and which to 20 mA. With these settings you can even invert the output, by assigning 20 mA to a smaller value than 0/4 mA. In case of controller output the output is in %, so you cannot set range min and max.

Note

If the outputs is assigned to control, the 22 mA alarm is deactivated. It needs to be reactivated if the output is reassigned to measurement.

18. Add-on ASR®

Our patented Automatic sensor cleaning feature ASR® is available for Neon® instruments as add-on. When activated, the submenu ANALOG of the IN/OUT menu is complemented with the cleaning-related parameters.

Note For the time being, ASR is not available for total chlorine sensors Zirkon® DIS Total®

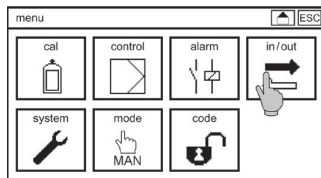

Select the symbol IN/OUT in the main menu, and in the submenu the symbol ANALOG, and then DIS 1. Subsequent to the usual parameters you find four more parameters that concern the cleaning function:

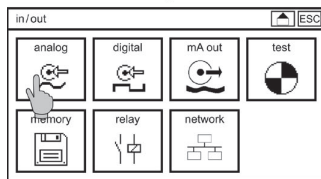

Base load

When activated, the instrument doses during cleaning with a constant controller output equal to the average of the last thirty minutes. Whenever this average is not available since the controller has not been running for 30 minutes after the last interrupt, cleaning is suspended.

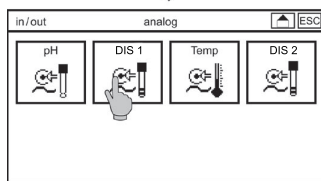

Warning

Base-load dosing is not monitored by measurement! Activate it only if no harm or damage can result!

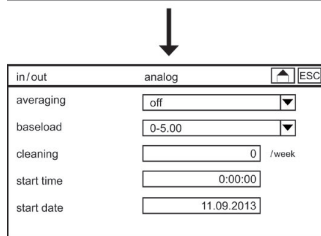

Cleaning

Here you can activate and deactivate the cleaning and select an interval of 0-7 times per week.

Note For most applications, 1 cleaning cycle per week is ideal.

Note If you select 0/week, the cleaning function is deactivated.

Start time

Here you define at what time the first cleaning cycle starts. If possible, select a time at which there is no or constant dosing. After the first cleaning cycle, the display switches to the time of the next cleaning cycle.

Start date

Define at what day the first cleaning is carried out. After the first cleaning cycle, the display switches to the date at which the next cleaning is scheduled.

Note **During the cleaning process, the measurement is switched off for a few minutes. The last measured value is frozen on the display and via the analog and digital outputs, and the controller is deactivated. In applications in which dosing stop cannot be tolerated, base-load dosing can be activated.**

Note **ASR® does not start if the event message “no water” or “check measuring input” is shown in the display or if you are currently in the calibration menu. The cleaning is delayed until 3 minutes after the eventmessage has dissapeared or you have left the calibration menu.**

18.1 ASR® for DIS 2

If you have activated DIS 2 and set it to Chlorine, you can activate ASR® for DIS 2. In that case, the second Chlorine measurement will be automatically cleaned together with the first one.

Note **For the time being, ASR® is not available for total chlorine sensors Zirkon® DIS Total®**

19. Add-on Modbus RTU

Neon® instruments are optionally available with a serial interface RS 485 Modbus RTU. To use this function you have to install the RS 485 circuit-board, observing the ESD-directive, and activate the software with the appropriate add-on code obtained from Dr. Kuntze.

When setting up a bus with several instruments, mind that the instruments are connected in line, not radially. Both ends of a long bus connection should be terminated with termination resistors of 120 Ohm. With Neon® instruments, you can activate the termination via menu.

Note **Activate the bus termination only at the ends of the line. If you activate terminations somewhere inbetween, this might cause malfunction in the bus communication.**

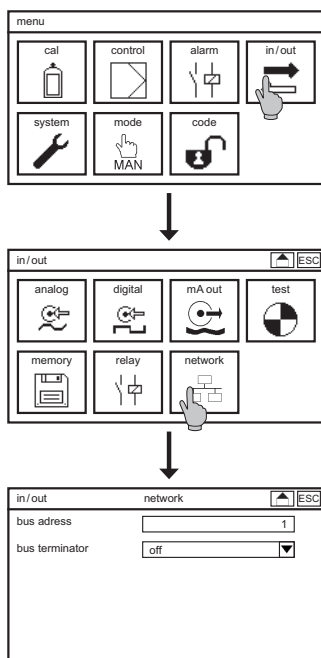

Select the symbol IN/OUT in the main menu and in the submenu, select the symbol NETWORK. Here you can set the following parameters:

Bus address

Assign a different number to each instrument in your bus system. With this number, you can address the instrument from the master instrument to read out data.

Bus termination

If you select ON from the drop-down list, the termination is activated for this instrument.

19.1. How to read out data

Request

| | | |
|-----------------------|---------|------------------|
| Function code | 1 Byte | 0x03 |
| Start register | 2 Bytes | 0x0000 to 0xFFFF |
| Quantity of registers | 2 Bytes | 1 to 125 (0x7D) |

Response

| | | |
|----------------|--------------|--------|
| Function code | 1 Byte | 0x03 |
| Bytes | 1 Byte | 2 x N* |
| Register value | N* x 2 Bytes | |

*N = quantity of registers

Write single register

| | | |
|---------------|---------|------------------|
| Function code | 1 Byte | 0x06 |
| Register | 2 Bytes | 0x0000 to 0xFFFF |

Write multiple registers

| | | |
|-----------------------|---------|-------------------|
| Function code | 1 Byte | 0x10 |
| Start register | 2 Bytes | 0x0000 bis 0xFFFF |
| Quantity of registers | 2 Bytes | 1 bis 125 (0x7D) |

19.2. Communication parameters

| | |
|-----------------|--|
| Baudrate: | 19200 bps |
| Data bits: | 8 |
| Stopp- Bits: | 1 |
| Parity: | even |
| MODBUS address: | selectable between 1-31, factory settings: 1 |

20. Operation and Maintenance of Neon® Multi and Krypton® Multi

20.1. Start-up

When you have connected all cables, turn the power on. At first, the instrument displays the time while it runs an automatic test routine, then it switches to the display of the measured values. If no water is flowing through the assembly, the message “no water” appears.

Set the parameters for the temperature measurement before you calibrate the other measurements.

Calibrate the pH measurement before you mount the sensor. For calibration you need two buffer solutions. Follow the instructions in the chapter pH calibration. At last, install all sensors in the assembly.

Before you connect the cables to the sensors, go to the menu IN/OUT => ANALOG => DIS 1 and check that the right parameter and measuring range has been selected, or change the settings if necessary. Changing the parameter while the sensor is already connected leads to a repolarization which can affect the measurement for quite some time.

Calibration of all disinfectant measurements is carried out with the sensor installed and the measurement running under normal measuring conditions, by means of a comparative determination of the current disinfectant concentration. Follow the instructions described in chapter Y – DIS calibration.

Continue the configuration with the settings for data outputs, limits and alarm, controller, etc. Make sure that all settings and measured values are correct and plausible before setting the controller to automatic mode.

20.2. Maintenance – operation mode

Never carry out maintenance while the controller is set to automatic. Select either manual mode or Hold.

In the manual mode only the controller is deactivated. All other functions such as the alarm relay and the test functions are still active. This mode is ideally suited to test the wiring to your PLC and to check the alarm functions.

With Hold, all alarm functions are deactivated. This mode is ideally suited to carry out maintenance such as cleaning of filters without issuing an alarm. With Hold, the controller is deactivated, and all analog and digital outputs are frozen to the last value, in case you are using these outputs as inputs for an external control.

20.3. Maintenance of the measurement

Maintenance of the measurement comprises cleaning of the various components, regular testing of safety features and gaskets, regular exchange of consumables, and the regular cross-check and, if necessary, calibration of the measurement.

Note **Maintenance intervals depend on the application, the installation, the accuracy requirements etc.**

| Operation | Interval suggestion |
|--|--------------------------|
| Cleaning of sensors and assemblies | 2 weeks |
| Cleaning of valves, filters, tubing etc. | 2 weeks |
| Refill of KCl (with KCl vessels) | Dependent on vessel size |
| Cross-check of the measurement | Weekly |
| Calibration | |
| pH | Weekly |
| all others | Whenever necessary |
| Checking the gaskets | Weekly |
| Testing the safety features | 2 weeks |
| Exchange of consumables | Six months / yearly |

20.3.1. Cleaning of sensors

Handle and clean sensors very carefully. Always use water and perhaps a soft paper tissue as the first cleaning agent. The pH-sensitive glass bulb of pH sensors is very thin and must not be mechanically damaged. The metal electrodes of the disinfectant sensors have very smooth surfaces to minimize dirt accumulation. Take care not to roughen these surfaces.

We recommend diluted hydrochloric acid to remove coatings of lime or hydroxides, and commercially available detergents to remove oil and grease. With organic coatings, hydrochloric acid with pepsine or thiourea is usually efficient, especially to open blocked junctions. Ceramic junctions can be cleaned mechanically, even abraded. For pH sensors make sure not to scratch the glass membrane in the process.

Total Chlorine sensors Zirkon® DIS Total should not be cleaned with detergents or acids, nor should the sensors be soaked in cleaning solutions.

Note **Keep your disinfectants sensors (except Zirkon® DIS Total) perfectly clean without any manual work with our patented automatic sensor cleaning function ASR®, which is available for Neon® instruments as add-on. Find more information in the chapter Add-on ASR®.**

Mind that after cleaning, all measurement takes a while to recover.

20.3.2. Refilling the KCl vessel (with refillable sensors)

When using refillable sensors, make sure that the level of the filling solution is always higher than the water level, and that the internal pressure is always slightly higher than the water pressure, to protect the sensor and to ensure its function.

Regular refilling of the vessel is especially important when the vessel is not visible, for example if it is installed in an immersion-type assembly.

Note **If due to neglected refilling, process water could enter the sensor, see the chapter “Trouble-shooting”.**

20.3.3. Cleaning of assemblies, filters, etc.

An important part of maintenance is the cleaning of all parts that come in contact with the water. Besides the sensors, this includes assemblies, pipes and tubes, filters, flow meters, cocks, valves etc. Coatings, deposits, and biofilm can adulterate the measurement, impede the water flow and at worst even damage the sensor.

Attention **We recommend to use only water and perhaps a soft brush for cleaning. Many synthetic materials are affected by acids or organic solvents!**

The assembly Stabiflow of the measuring system Krypton® Multi is equipped with a filter. To clean the filter, unscrew the inlet, take out the filter and rinse it clean. Take care during reassembly that all components and seals are in their proper position.

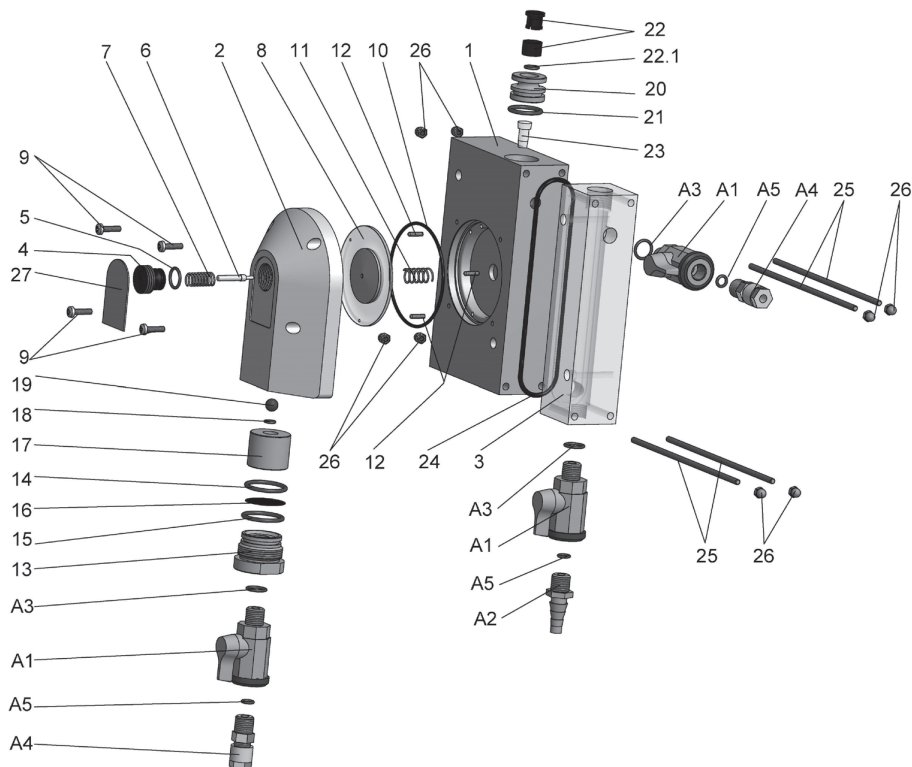

20. Operation and Maintenance of Neon® Multi and Krypton® Multi

| No. | Description |
|------------|-------------------------------|
| 1 | Main body |
| 2 | Membrane chamber (inlet side) |
| 3 | Measuring cell Argon® |
| 4 | Adjusting screw PG13.5 |
| 5 | O-ring 12x2 |
| 6 | Valve pin |
| 7 | Coil (inlet side) |
| 8 | Assembly group "membrane" |
| 9 | Screws Phillips M4x16 |
| 10 | O-ring 73x2 |
| 11 | Coil (outlet side) |
| 12 | Threaded pins M3x13 |
| 13 | Hex spud |
| 14 | O-ring FKM 26x2 |
| 15 | O-ring FKM 26x2 |
| 16 | Filter |
| 17 | Filter support |
| 18 | O-ring 5x1.8 |
| 19 | Ball |
| 20 | Multisensor holder |
| 21 | O-ring 19x2.5 |
| 22 | Quick-lock coupling |
| 23 | Float |
| 24 | O-ring 108x3 |
| 25 | Threaded rods M4 |
| 26 | Dome nuts |
| 27 | Label |
| A1 | Stop cock |
| A2 | Hose barb |
| A3 | O-ring 11x3 |

20. Operation and Maintenance of Neon® Multi and Krypton® Multi

| No. | Description |
|-----|----------------------------|
| A4 | Tube connector DN 6/8 1/4" |
| A5 | O-ring 6x3 |

20.3.4. Calibration of the measurement

The response characteristics of sensors change over time, even without use, so the measurement has to be checked against a comparison method at regular intervals and calibrated if the deviation is too pronounced.

The instrument checks the calibration results after calibration and displays an event message if the sensor has to be cleaned, regenerated, or replaced. Refer to Trouble-shooting for more information.

20.3.5. Checking the gaskets

Especially in pressurized applications all gaskets and sealing rings must be checked regularly and replaced at needs. Make sure to use only spare parts consistent with your application and your equipment. Check the proper placement before reapplying pressure!

20.3.6. Testing the safety features

Regularly test all safety features, especially when using control functions. Check the function of water level or flow sensors and verify that the controller is automatically shut down in a low-water situation.

Simulate such an event by impeding the water flow temporarily or by lifting the level sensor out of the water. Switching of the level sensor or loss of the flow signal has to lead to the text message "low water" or "level" or "ext. controller stop" according to settings, and to an automatic controller stop.

Regularly test the function of the alarm relay and ensure that in case of an alarm, the instrument issues the alarm and the connected control center registers the alarm correctly. With the aid of the test menu, such test is easily accomplished.

Note **In the HOLD mode, the alarm function is deactivated.**

20.3.7. Exchange of consumables

Besides the sealing rings and the KCl solution, buffer solutions and sensors are typical consumables. Buffer solutions should always be kept cool and out of direct sunlight. Open bottles should not be stored for too long – alkaline solutions tend to absorb carbon dioxide from the air, and acidic solutions often contain organic acids, providing nutrients for microbiological growth.

Never put used solution back into the bottle. Nowadays a variety of single-use sachets with certified accuracy are available. These sealed sachets can be stored without changes over long periods of time and eliminate one of the mayor uncertainties in case of calibration problems. The operating life of the sensor depends strongly on the application and the measuring conditions. The info menu of the calibration menu shows the results of the last 10 calibrations which gives you an idea on the condition of your sensor. If the slope approaches the tolerated limit, it can be expected that it will give a calibration error and has to be replaced in the near future.

If you have to exchange a sensor, make sure that the replacement fits your equipment and your application. Remember that you probably have to calibrate when you change a sensor.

Recalibration is also necessary if you exchange the instrument.

Note **Cables also tend to wear out, especially if they are frequently unplugged. Find more information in the chapter “Trouble-Shooting”.**

20.3.8. Restarting

Restarting is to be carried out like the original start-up. Follow all steps described in this manual.

Before opening the water inlet, make sure that the flow is not impeded or interrupted anywhere. When using assemblies that can hold several sensors, make sure that all holders are occupied or closed with a blind. Make sure that all valves are in the right position (for example, inlet and outlet open, sampling point closed). Check that all screw connections are sealed tight before applying pressure.

pH measurements have to be calibrated at the beginning. Mind that the temperature has to match that of the buffer solutions by either placing the temperature sensor in the buffer or by setting the temperature manually.

After installing the sensors, wait until all measurements are stable, and check if the measured values are plausible, before activating the controller. Also check all settings, especially for controller and alarm, and make sure that the feed lines are properly connected and undamaged.

Note **Use all safety features the instrument provides, such as the alarm relay, the limits, the dosage check, and the controller stop.**

20.4. Decommissioning and disposal

If you want to take the measurement out of service for a while, mind the storage conditions listed in the data sheets, especially regarding temperatures. Store sensors always in solution, preferably in 3M KCl, never in deionized water or aggressive solutions. We advise to use for storage the protective covers in which the sensors were delivered. If you want to use other beakers, use plastic instead of glass to avoid damage to the sensors, and ensure that the storage solution always covers the junction.

Store instruments and cables in a cool, dry, and dark place, protected against dust.

If you want to dispose of the instrument permanently, mind that it contains electrical components that have to be disposed of following national directives.

20.5. Facilitating functions

20.5.1. Store and load settings via SD card

You can store your settings on an SD card and reload them anytime to ensure that the settings are not lost during maintenance.

This function can also be used to duplicate settings into other instruments of the same type and parameter or to recover your settings after a software update or an upgrade via add-on. Additionally, you can do all settings comfortably on your PC, using the Kuntze configuration software, and then load the settings into the instrument via SD card. The configuration software is available free of charge.

20. Operation and Maintenance of Neon® Multi and Krypton® Multi

20.5.2. Software update via SD card

With the SD card you can also install software updates. Copy the two software files you have received from us onto the SD card (not in a subdirectory). Plug the SD card in the instruments slot, and load the files via SYSTEM => MEMORY => LOAD => SOFTWARE.

20.5.3. Test menu

During start-up, or in case of an alarm in your control center inconsistent with the measured values, the test menu will help you test the communication between instrument and control center.

In the test menu you can operate all relays manually, and set fix values for each available mA output.

The test menu can only be used in the Manual mode. The test menu is a submenu of the menu IN/OUT.

21. Trouble-Shooting

In case of an event, the Neon® Multi instrument provides a variety of functions to assist you:

- > Event messages on the display, declaring the nature of the event.
- > An event help containing suggestions how to solve the problem.
- > An event log that stores up to 100 event messages
- > An info menu, showing all settings and current values
- > A reset function to restore factory settings
- > A diagnosis file in case that you need external help. The diagnosis file will allow your contact person to assess the situation.

21.1. Useful accessories for trouble-shooting

- > PH-T: Our pH/mV simulator makes testing instruments and sensors easy, since you can use it to test sensors, check cables, and test instrument functions. On the next pages you will find detailed information on when and how to use the PH-T.
- > Short-circuit wire: With pH meters, a simple wire bridge allows a simple test of the measuring input. If you short-circuit the terminals of the measuring input, the instrument will show 0mV or approx. pH 7, respectively. Attention: The pH value depends on the current calibration values! If you had last calibrated with an internal buffer of pH 2, for example, the displayed value will be approx. pH 2 instead of pH 7. However, the mV value will always be 0mV (+/-3mV).
- > Spare buffer solutions: If a buffer solution does not have the pH value that it is supposed to have, you can waste a lot of time on fruitless tests of all measuring components. Such deviations can for example be caused by absorption of carbon dioxide from the air, or by immersing a sensor without rinsing it off first. Nowadays, a variety of buffers are available as single-use sachets. They can be stored until needed and pack quite small.
- > ORP buffer: For ORP sensors, buffer solutions are available as well. They are used just like pH buffers – when you immerse the sensor, the reading should be that indicated on the buffer bottle. Attention: ORP buffers can be very aggressive and can dissolve or damage plastic materials!
- > Radon: Our portable photometer with its convenient case allows a quick and easy comparative measurement. It comes equipped with reagents for the determination of Chlorine, Chlorine dioxide, and Ozone, and can be used to check and calibrate the online measurement.
- > Test plug: With Des meters, the test plug allows a simple test of the measuring input. If you connect the test plug to the cable of the Des sensor, the instrument will show as raw measured value approx. the mV indicated on the plug. The value depends on the parameter and the selected measuring range.

Attention **The measured value on the desktop is generally zero when you connect the test plug since the mV do not fit the measurements!**

- > Spare sensor: Sensors are consumables, and fragile. Exchanging a sensor can speed up trouble-shooting: If the problem remains, it was probably not caused by the sensor. If it has vanished, the sensor needs to be replaced or at least cleaned and regenerated.
- > Spare cable: Cables are frequently causing trouble – damaged contacts or insulations lead to malfunctions very similar to those caused by sensor defects. With a spare cable, such malfunctions can easily be identified and solved.

21. Trouble-Shooting

21.2. Contact

In **SYSTEM => CONTACT** you can store contact data of a contact person who might help in case of problems. With restricted access (code 0202) this data can be viewed if not altered.

Note You can have the contact data displayed on the desktop, if you select “contact” as desktop design in the menu **SYSTEM => DISPLAY**.

21.3. Diagnosis file

In case of problems, it might be useful to provide an external contact person with an overview of the current situation. To that purpose save the diagnosis file on your SD card. It contains all current values and settings and the eventlog.

21.4. Info

The Menu **SYSTEM -> INFO** contains all information on your instrument, the settings, and the current values, such as:

ID

Here you can find the instrument number, the software versions, and the operation hours. This information is important for repair, updates, etc.

Eventlog

The eventlog lists up to 100 events with the times of their appearance and disappearance. Further details are supplied on the following pages.

Settings

This menu lists all settings. In case of trouble, check if all settings are as you had intended, and check if the instruments behavior is consistent with the settings. If for example the alarm relay is not activated when the measured value drops below the lower limit, this might be because you have not activated the lower limit as an alarm action in the alarm action list.

View

This menu shows all current values of analog and digital inputs and outputs, including the raw signals of the sensors. The latter are invaluable for trouble-shooting since they are not affected by any user settings such as calibration, temperature compensation etc. If for example you get a slope error after calibration, even though the raw signals of the sensor were plausible, then the problem might well be a defective or missing temperature measurement, and an exchange of the Des sensor would be quite useless.

The raw data is also especially useful if the instrument has been hopelessly miscalibrated. The information on mA output values and status of the digital inputs help locating communication problems with the control center. mA values can be measured at the terminals of the instrument with an amperemeter.

Note **The mA outputs are add-ons. They are displayed only if the functions have been activated.**

21.5. Event messages

In case of trouble, the instrument displays an event message on the desktop. If there are more than one message, they are displayed alternately.

Not all events will cause the alarm relay to switch. For many events you can decide for yourself if the relay should switch by defining the event as an alarm action in the alarm action list – see Alarm relay.

You can choose in the menu ALARM => CONFIRM if an event should be shown until a user has confirmed the event. The readout via alarm relay is not affected.

21.6. Eventlog

Up to 100 events are saved in an eventlog. The *-sign indicates appearance, the #-sign disappearance. Besides the event messages, this also lists power interrupts, calibrations, and similar operations, with date and time.

This helps to interpret events – for example a deviation of the measured value shortly after a power interrupt may simply be due to the unfinished polarization of the measurement.

| system | event log | ESC |
|------------|-----------|--------------|
| 21.08.2012 | 14:05:23 | *start |
| 26.07.2012 | 21:09:38 | #relay 3 |
| 26.07.2012 | 21:09:38 | #lower limit |
| 26.07.2012 | 20:50:05 | *relay 3 |
| 26.07.2012 | 20:50:05 | #upper limit |
| 19.08.2012 | 10:15:57 | *calibration |
| 19.08.2012 | 10:11:10 | *start |

The eventlog provides information on frequency and duration of events. You can see what events have occurred in the past, and how long they lasted. The appearance and disappearance times allow to check what other events had happened at that time, for example the start-up of a dosing pump, frequency inverter, etc.

Note You can save the eventlog by saving the diagnosis file.

21.7. Event help

As an addition, the instrument provides help for all events: information on possible causes, and suggestions for possible remedies. These can be found in the menu SYSTEM => EVENT, or – with touch screen instruments – by touching the event message on the desktop.

We advise to follow the suggestions in the order in which they are presented.

| Event message | Cause | Suggested remedies |
|---------------|--|---|
| pH zeropoint | After calibration, the zeropoint was not within -60...60mV | Check settings buffer/internal buffer; repeat calibration Change reference electrode/ change sensor |

If you get a zeropoint error, the zeropoint after calibration did not fit your calibration settings. This might simply be because the settings did not correspond to the buffers or the sensor that you used.

21. Trouble-Shooting

Note **The internal buffer is the buffer filled into the pH-glass bulb. The pH of this buffer represents the zeropoint of your sensor. You can find the pH of the internal buffer printed on the sensor, whenever it is not pH 7.**

If all settings were correct, the problem might still be caused by one of the solutions, if it does not have the expected pH. If you have a spare buffer at hand, you can check if it gives the same results.

With a zeropoint error, the menu SYSTEM => INFO => VIEW is helpful, since it displays the raw signal of the sensor, unaffected by the current calibration. The raw signal is displayed in mV. If the internal buffer is pH 7, then a calibration buffer of pH 7 should yield a signal around 0 mV. Deviations of less than 1 pH (approx. 60mV) are tolerated.

Checking the zeropoint with the PH-T

The raw sensor signal can be checked using the PH-T: Connect the sensor to the cable of the PH-T and set the PH-T to M2/mV read-out. Immerse the sensor in a buffer solution corresponding to the zeropoint of the sensor, usually pH7. The PH-T shows the sensor signal as mV, the value should be within -60...+60mV. Since you are now using a different instrument and a different cable, a comparison between the signals displayed by the instrument with those displayed by the PH-T helps to determine whether the problem lies with the sensor or with the cable or instrument.

If the signals found with the PH-T are fine, then you can use the PH-T to check the instrument and the original cable: Use the BNC/COAX adapter and connect the PH-T to the pH cable of the instrument as if it were a sensor. Set it to M1/mV output and the value to 0mV. Now the instrument should read 0mV (+/-3mV). If not, repeat with a different cable. Use more mV values to check the response of the instrument.

If the error is not caused by the instrument or the cable, it might be caused by the sensor. This might be due to a worn-out or poisoned reference or due to a worn-out or coated pH-membrane. Check the glass bulb and the reference, especially the junction and the reference element, for damages or discoloration. Clean the sensor if necessary. See Maintenance of the measurement. Check that the bulb and the reference are filled with liquids. Gently shake the sensor to make sure that all filling solutions collect at the bottom of the sensor and that any captured air rises to the top.

It might help if you heat the sensor with hot tap water and let it cool immersed in 3M KCl (the filling solution of the protective cover the sensor was delivered in). This cleans the junction and fills it with salt to ensure a good electrical connection between measuring and reference electrode.

With refillable sensors, a high zero-point error occurs if the level of the filling solution dropped below the water level, and process water could enter the sensor. If the sensor still looks normal, it is worth the trouble to empty and refill it with fresh 3M KCl solution. Wait 24h and then check the zeropoint again.

If all your efforts did not lead to an improvement, you will have to exchange the sensor.

| Event message | Cause | Suggested remedies |
|---------------|--|--|
| pH slope | After calibration, the slope was not within 50...65mV/pH | Check buffers, check temperature repeat calibration change sensor |

Here again the problem might be caused by an improper or spoiled buffer. Furthermore, the slope depends on temperature – at low temperatures it is smaller than at high temperatures. Therefore, an improperly set temperature compensation or a defective temperature sensor will lead to a slope error.

As with the zeropoint, the raw signal of the sensor helps interpret slope problems. The sensor emits 50-60mV per pH at room temperature. If you keep in mind that pH 7 is your zeropoint, giving 0mV, then each pH unit that you move away from pH 7 will give you 50-60mV – positive for acidic solutions, negative for alkaline solutions. In buffer pH 4 for example you should find approx- 150-180mV more than in buffer pH 7. If you divide the difference between the two mV readings by three (the pH difference of the two buffers), you will get the slope of the sensor– uninfluenced by temperature compensation or any previous calibration.

Example::

| | |
|----------------------|--------------------------|
| <i>In pH 7</i> | <i>12 mV</i> |
| <i>In pH 4</i> | <i>186 mV</i> |
| <i>Difference</i> | <i>186-12 = 174 mV</i> |
| <i>pH difference</i> | <i>7-4 = 3</i> |
| <i>Slope 1</i> | <i>74 / 3 = 58 mV/pH</i> |

Note **Slope error might also occur if you have neglected to pay attention to the temperature influence on the pH values of the calibration buffers – see Calibration – settings.**

A low slope can also be the result of contact problems, or more accurately if the insulation is not as high as it has to be. Damaged cable insulations, or water inside the connector, or worse, inside the instrument, can cause signal loss. These possibilities can be checked with the PH-T. Besides the functions described so far it provides a high-impedance test, during which the displayed values will change dramatically if there is any problem with the insulation.

High-impedance test with PH-T

Connect the PH-T to the pH cable of the instrument like a sensor. Select the function M1 / mV output, and set the output to approx. 180mV. Enter the menu SYSTEM=>INFO=>VIEW to see if the instrument displays this value +/-5mV. Activate the high-impedance test of the PH-T by pressing the key MOhm, and see if the value displayed by the instrument drops dramatically. If it does not, instrument and cable are probably okay.

Note **The high-impedance test consumes a lot of energy. Deactivate the test after some seconds.**

If these causes can be ruled out, then the focus turns towards the sensor, especially towards the pH-membrane which might be coated or worn out. Check it for discoloration and damages, and clean it if necessary. Information on sensor cleaning can be found in the “Maintenance of the measurement”.

Some pH glasses can be reactivated with aggressive solutions such as acids. However, this should only be done by trained personnel.

If cleaning or regeneration did not improve the results, you will have to exchange the sensor.

Note **Zeropoint and slope error messages will remain until a new calibration yields values within the tolerances – or until somebody resets all settings to factory settings.**

Note **If the instrument issues a calibration error (zeropoint or slope), check the INFO menu in the calibration menu. It lists the results of the last calibrations with date and time and helps determine whether the current results are following a general trend or if the current results differ greatly from previous results, making a damage or some calibration error more likely.**

21. Trouble-Shooting

| Event message | Cause | Suggested remedies |
|-------------------|--|---|
| DIS 1/DIS 2 slope | After calibration, the slope was not within the tolerances | check reference check temperature repeat calibration change sensor |

If this message appears, first check what the slope value is. If the value lies between zero and the tolerated minimum, the sensor signal output is too low.

| Measuring range | Ideal slope | minimum |
|----------------------|-----------------|-----------------|
| 0-1000 µg/l | 100mV/ 0.1 mg | 20 mV |
| 0-5.00 mg/l | 20 mV/ 0.1 mg | 4 mV |
| 0-10.00 mg/l | 10 mV/0.1 mg | 2 mV |
| 0-20.00 mg/l | 5 mV/ 0.1 mg | 1 mV |
| 0-30.00 mg/l | 3.3 mV/ 0.1 mg | 0.66 mV |
| For Zirkon DIS Total | 10 mV/ 0.1 mg/l | 2 mV / 0,1 mg/l |

“Ideal slope” refers to the at-works setting. The real slope can vary from that value, depending on measuring conditions, and, with Zirkon DIS Total, on the substances to be measured. If your slope is too low, switch to a lower measuring range. If the slope is too high, switch to a higher measuring range. If the current slope does not fit the trend of the last calibrations, an error in procedure or settings is more likely.

A low slope can for example be the result of wrong or missing temperature compensation. Also check the current zeropoint displayed in the calibration menu. Especially at low concentrations, an erroneous zeropoint calibration can seriously interfere with the slope calibration. Check the zeropoint in tap water and in a sample of disinfectant-free process water by taking a sample of approx. 0.5-1l in a beaker and stirring the sensor in it. The signal you get will not be very stable, but at least it will give you an idea on whether the zeropoint calibration had been correct or not. If not, recalibrate the zeropoint and repeat the slope calibration.

If the slope is 500, check the raw signal – if this fits the current concentration, most probably somebody has inadvertently carried out a zeropoint calibration at this concentration, making the instrument believe that the same sensor signal corresponds to both zero and a higher calibration, which renders slope determination impossible. Correct the zeropoint calibration and then recalibrate the slope.

If the slope is exactly zero, there was no measuring signal during calibration. This can be caused by lack of measuring water, a cause that should cause an event message in itself, or by a missing contact.

Make sure that a sensor is connected to the instrument, and that the cable is properly connected both to the sensor and to the instrument. To test the proper connection, attach the testplug to the sensor cable and check if the instrument shows as raw value the mV indicated on the plug. If you have no plug, you can test the connection by short-circuiting the two metal electrodes of the Des sensor, for example by holding a piece of metal wire or a screwdriver to both electrodes – this redirects the instruments internal potentiostat to the measuring input, instantly overloading the input and causing the message “check measuring input” to appear.

If this test fails, disconnect the cable from the instrument and use an Ohmmeter to check the resistance between the measuring electrode (the upper metal ring) to the brown wire, and the counter electrode (the lower metal ring) to the blue wire. Both resistances must be in the 0-10Ohm range to show that the connection is OK. The connection of the reference can also be measured, if you put the Ohmmeter tip to the junction of the Des sensor, preferably with a piece of wet tissue inbetween; however, here the resistance is in the kOhm range.

If the contacts are all OK, the process water might not contain any disinfectant, possibly due to consumption, or at least not the disinfectant selected as measuring parameter. Here again, take a sample of process water in a beaker and stir the sensor in it. Add some disinfectant manually. The signal will be instable, and the dosing probably quite high, but this provides an easy test to verify that the measurement responds to the disinfectant dosing. When you get the expected reaction, repeat the test with a second sample and add the disinfectant slowly until a strong positive signal occurs. This will tell you something on the disinfectant consumption of your water.

Note **The slope message remains until a new calibration yields values within the tolerances – or until somebody resets all settings to factory settings.**

If calibration problems occur with sensors with refillable reference, the filling solution might be the cause of the problem. If you can, check the reference potential against another reference, for example with a pH- or ORP instrument. The potential should be around 0mV. If not, empty the reference and refill it with fresh 3M KCl solution. Remove any air bubbles from both the sensor and the connected KCl tube.

| Event message | Cause | Suggested remedies |
|--------------------------|---|--|
| pH check measuring input | The measuring input receives no proper signal | Check sensor plug, check cable, check sensor |

This message appears if the measuring circuit is interrupted.

Here again the cause may be quite simple – the connector might not be properly plugged to the sensor, or the wires of the cable might not be properly screwed into the terminals. The cable might be broken somewhere, typically at the uninsulated ends. You can check the cable with a common multimeter and cable and measuring input of the instrument with the PH-T.

Testing the input with the PH-T

Connect the PH-T with the BNC/Coax adapter to the pH cable of the instrument, as if it were a sensor. Select the function M1/ mV output, and check if the mV values you set with the PH-T are properly recorded by the instrument in the menu SYSTEM=>INFO=>VIEW. Deviations up to 5mV are irrelevant. If you find large deviations, repeat the test with a different cable. Also check if the signal changes abruptly if the cable is gently moved in the vicinity of the sensor head.

If all tests turn out well, the problem is probably located at the sensor. The simplest explanation is that the sensor is not sufficiently immersed. Make sure that the sensor is immersed at least so that the junction is completely covered.

With refillable sensors, the measuring circuit is interrupted if the level of the filling solution drops below the reference element or, with double-chamber sensors, below the internal junction. In that case refill the sensor and remove any air bubbles within the internal junction by gently shaking the sensor.

The easiest way to check if a sensor is defective is to connect another sensor or the pH-T to the instrument to see if it shows the same results. If the measurement works fine with the other sensor, check the contact in the original sensor's connector and open the spring parts of the central pin slightly and carefully to ensure good contact to the cable.

21. Trouble-Shooting

If the problem lies with the sensor but not with the connector, try to clean the junction to open it up in case it is blocked. Ceramic junctions can even be abraded. If you heat the sensor under hot tap water and let it cool in 3M KCl, the junction fills with salt solution to give good contact via the junction.

Check for air bubbles inside the sensor – any bubbles in the area of the junction and the glass bulb have to be removed. Shake the sensor gently to make the bubbles rise to the top of the sensor so that the bottom part of both measuring and reference electrode are completely filled with liquid.

If all these measures do not solve the problem, the sensor has to be exchanged.

If the sensor is no older than six months, we strongly advise to send it in for examination. If the examination shows a defect that you could not have caused, you will receive a replacement free of charge, and if not, then at least you will know the cause of the trouble and be able to prevent a repetition.

| Event message | Cause | Suggested remedies |
|----------------------------------|---|---|
| DIS 1/DIS 2check measuring input | The measuring input receives no proper signal | Check input, check sensor plug, check cable, check sensor |

This message appears if the measuring input is overloaded, an indication that too strong a current is detected. This can happen during installation, due to the polarisation current that is necessary to condition the sensor, especially in low measuring ranges and with Zirkon DIS Total. Switch to a higher measuring range to speed up the polarisation process. Switching to a higher range is the measure of choice even when the message appears during operation, since an overload may well be a result of too high concentrations. If it is not, remove the sensor from the process water to ensure that the fault current is not a result of the installation. If the message remains, it is probably caused by a short-circuit between the measuring and the counter electrode, either within the sensor or within the cable.

Disconnect the sensor from the cable – if the event message remains, disconnect the cable from the instrument. If the message disappears now, exchange the cable. If the message disappears as soon as you disconnect the sensor, the problem lies within the sensor. Dry the sensor and measure the resistance between the two metal electrodes. There should be no connection between them. A short-circuit between the two electrodes redirects the current from the internal potentiostat to the measuring input, causing overload. Such a short-circuit can occur if the sensor body was damaged and water gets into the inner glass rod of the sensor.

| Event message | Cause | Suggested remedies |
|---------------------------|---|---|
| STD check measuring input | The measuring input receives no proper signal | Check input, check sensor plug, check cable, check sensor |

This message appears if the measuring input is overloaded, an indication that too strong a current is detected. Remove the sensor from the process water to ensure that the fault current is not a result of the installation. If the message remains, it is probably caused by a short-circuit between the measuring and the counter electrode, either within the sensor or within the cable.

Disconnect the sensor from the cable – if the event message remains, disconnect the cable from the instrument. If the message disappears now, exchange the cable. If the message disappears as soon as you disconnect the sensor, the problem lies within the sensor.

| Event message | Cause | Suggested remedies |
|-------------------------|---|---|
| Check temperature input | The temperature input receives no proper signal | Check Pt100/Pt1000 Check cable Without sensor use manual compensation |

If the temperature input does not receive an appropriate signal, you may have selected automatic temperature compensation although no temperature sensor is connected. In that case switch to manual compensation. It is also possible that a Pt100 was connected but the compensation was set to Pt1000, or vice versa.

If you have connected a Pt100 or Pt1000, check if you have used the right terminals for connection and the right settings of the jumper next to the terminals.

As with the measuring inputs, a defective cable or sensor can be the cause for this message. You can check temperature sensors with an Ohmmeter – a Pt100 has a resistance of approx. 109 Ohm at room temperature, a Pt1000 approx 1080 Ohm.

| Event message | Cause | Suggested remedies |
|------------------------|--|-----------------------|
| Out of measuring range | Measured values exceed the measuring range | Trend indication only |

If the measured value lies outside the measuring range but can still be processed by the instrument, it will be displayed together with this message. Please note that all information on accuracy, linearity, influences of temperature etc specified in the data sheets, only apply to values within the measuring range. Outside this range, the deviations and cross-influences might be higher, and the measurement can only be used as an indication.

If your instrument allows to select from a variety of measuring ranges, select the next higher range.

If the measured value gets so high that it can no longer be processed, the message „check measuring input” will appear.

| Event message | Cause | Suggested remedies |
|--|---|--|
| Upper limit (or lower limit, respectively) | The measured value is higher than the upper limit (or lower than the lower limit, respectively) | Check dosage check controller parameters keep in mind delay settings |

If the measured value exceeds the limits, this might mean that the feeding of control chemicals has been interrupted, because a reagent is empty, or the controller was stopped, or a feed line is damaged.

Warning **If this message was caused by a defective feed line, hazardous chemicals might leak from the break!**

Note **In that case a second message „dosage check“ is probably displayed, if you have activated this function and your controller settings do not impede the function.**

21. Trouble-Shooting

If the message occurs shortly after start-up and possibly quite frequently, please check the settings for control and limits to make sure that they match both each other and the requirements and conditions of your equipment. Perhaps the controller has to be set to slower reactions by choosing a larger proportional range to prevent overdosing.

Note **Temporary limit exceedance that might happen regularly during normal operation can be ignored by setting a delay time in the menu Alarm relay.**

| Event message | Cause | Suggested remedies |
|---|--|---|
| Digital input 1-6 Low water Level Ext. controller stop | The digital input was closed by a connected sensor or switch | Digital input 1 : Low water Check water flow, check sensor/connection Digital input 2: external controller stop Digital input 3 and 4: Level pH/ Level DIS 1 Digital input 5: ECO contact via DI5: 2nd parameter set and relay 7 = circulation is active Digital input 6: Leakage control Check pumps and dosing tubes Digital input 6 active - 3rd parameter set and relay 8 = filter backflush is active |

The digital inputs are assigned to their functions. The digital inputs 1 - 4 allow connection of a flow sensor, level sensors and an external switch. The digital inputs 5 and 6 can be used to activate the 2nd and 3rd controller parameter set.

Note **Switching of digital input 1 and 2 as well as 6 if set to leakage control stop all controllers, switching of digital input 3 only stops the pH controller and switching of digital input 4 stops the controller DIS 1.**

Depending on these settings, the suggested remedies differ: If you have selected „low water“ or „level“, the instrument suggests checking the availability of water or reagent, and if that is ok, the proper function of the flow or level sensor.

| Event message | Cause | Suggested remedies |
|---------------|---|--|
| Dosage check | Controller output was 100% for longer than the specified time | Check dosing, especially feed lines and pump |

Dosage check is a safety measure to shut down the controller in case of defective feed lines to prevent leaks of hazardous chemicals.

The instrument monitors the time of dosing with 100% controller output – if you are using the instrument's controller and have activated this function by setting the time to a value >0. If within that time the

controller output does not go below 100%, the instrument shuts down the controller, stops the dosing, and displays this message.

Further messages with activated add-ons:

| Event message | Cause | Suggested remedies |
|----------------------|--|--------------------|
| Cleaning in progress | The automatic cleaning ASR® has just been started. | None |

This message appears when the automatic cleaning is carried out. The measured value is frozen to its last value on the desktop and via analog and digital outputs, the controller is deactivated or switched to base-load dosing, according to settings, and the calibration menu is inaccessible. The message disappears automatically as soon as the measurement has returned to normal.

| Event message | Cause | Suggested remedies |
|-----------------|---|--------------------|
| mA out of range | The current measured value corresponds to an output outside the 0(4)-20 mA range. | Check settings |

This message appears if the measured value is higher than the one assigned to 20 mA or lower than the one assigned to 0/4 mA.

Example:

You have set the mA output to 0-1 mg/l. The output is 0(4) mA at 0 mg/l, and 20 mA at 1 mg/l. If your measured value is 1.2 mg/l, this message will appear.

Check the settings for the analog outputs, and change the settings if necessary.

| Event message | Cause | Suggested remedies |
|----------------|---|--------------------|
| Load impedance | A mA output has been activated but is either unconnected or the connection is broken. | Check connection |

The instrument monitors the Ohmic load of the mA outputs and can detect if a connection is broken. If an output is not connected at all because you do not want to use it, do not assign it to any measurement.

Finally, there are some event messages indicating fundamental problems that you cannot solve on site:

| Event message | Cause | Suggested remedies |
|---------------------|---|-----------------------|
| Communication error | The internal communication between instrument parts does not work | Contact your supplier |

If such a message appears, the instrument has to be sent in for repair.

21.8. Events with Popup messages

In some events, a window pops up, displaying a message. Just note its contents, or follow the instruction. To close the window, you have to acknowledge with OK.

| Popup message | Cause |
|-----------------------|------------------------------------|
| Check measuring input | The measuring input is overloaded. |

If you try to calibrate while the event message „check measuring input“ is displayed and instead of a measured value question marks are displayed, this popup appears. Without a suitable measuring signal calibration is impossible. Refer to the procedures described for the event message “check measuring input”.

Calibration is possible only after the event message has dissapeared and regular measured values are displayed.

| Popup message | Cause |
|-------------------------|---|
| Check temperature input | During calibration the temperature input receives no signal |

If you try to calibrate while the event message „check temperature input“ is displayed and instead of a temperature value question marks are displayed, this popup appears. Without a suitable temperature signal calibration is impossible. Refer to the procedures described for the event message “check temperature input”.

Calibration is possible only after the event message has dissapeared and regular temperature values are displayed.

This can be achieved by switching the temperature compensation to manual.

| Popup message | Cause | Suggested remedies |
|---------------|---------------------------------------|--|
| SD card error | The instrument cannot use the SD card | No SD card Invalid format Invalid file SD card full |

Check if an industry-standard SD card has been plugged into the slot, and that it was plugged properly. If you want to load settings or update files, check that the files are available on the SD card directly and not in a subfolder. Delete and restore the files, if necessary. If you want to store settings on the SD card, check if there is enough storage space left on the card.

This message appears also if you remove the card without deactivating the logger first.

| Popup message | Cause | Suggested remedies |
|----------------------|-------------------------------------|---|
| No appli | The software files cannot be loaded | Please renew the 2 data files on the SD card and try again. |

For updates, both files have to be stored on the SD card, not in a subfolder. Check that the files are available, and delete and restore them if necessary.

| Popup message | Cause | Suggested remedies |
|--------------------------|-----------------------|-------------------------------------|
| Memory stop data logging | The SD card is fulll. | SD card full, data logging stopped. |

If you have set the logger to STOP mode, then the instrument stops the logging when the SD card is full.

Change the SD card, or remove some of its contents, or select the mode RING to overwrite older data.

| Popup message | Cause | Suggested remedies |
|----------------------|----------------------|---------------------------|
| Check batterie | No or empty batterie | Change batterie |

After start-up the instrument checks the batterie. If the batterie is missing or provides too low voltage a popup is shown. In this case please change the batterie.

21.9. Reset

As a last resort it is sometimes necessary to restore factory settings or start configuration. With the RESET function you erase all settings by operators. Activated add-ons will of course remain activated.

With the Reset function, the system is set to a defined condition. User settings that might severely impede an evaluation of the measured values, such as a calibration gone wrong, are erased.

Index

A

| | |
|--------------------------|----|
| Action | 72 |
| Actuator CI | 74 |
| Add-on activation..... | 66 |
| Add-on Datalog | |
| intervall | 86 |
| Alarm action | 72 |
| Alarm confirmation | 73 |
| Alarm relay | |
| action list | 72 |
| delay | 71 |
| limit values | 71 |
| settings | 71 |
| Analog input | 34 |
| Analog output | |
| 0/4-20mA selection | 87 |
| 22 mA alarm | 87 |
| assignment | 87 |
| range | 87 |
| range min/max | 87 |
| ASR® | 88 |
| base load | 88 |
| cleaning | 88 |
| start date | 89 |
| start time | 89 |
| Autolock | 60 |
| Automatic mode | 33 |

B

| | |
|-----------------------------|----|
| Base load during ASR® | 88 |
| Bus address | 90 |
| Bus termination | 90 |

C

| | |
|-----------------------------------|--------|
| Calibrate Des | 42 |
| Calibrate pH | 40 |
| Calibration | 48, 96 |
| info | 48 |
| Check temperature input | 110 |
| Cleaning | 88 |
| Cleaning of sensors | 93 |
| Code | 31, 32 |
| Communication error | 109 |
| Conductivity measurement | 39 |
| Connection diagram | 16 |
| Contact | |
| data contact person | 62 |
| Contrast (display) | 59 |
| Controller | |
| activation and deactivation | 81 |
| actuator CI | 78 |
| automatic controller stop | 82 |
| manual operation | 81 |
| P range | 76 |
| PID controller | 76 |
| PI controller | 76 |

| | | | |
|------------------------------|----------|----------------------------------|---------|
| pulsepump / pulsepumps | 77 | I | |
| D | | Info | |
| Datalog | 84 | calibration | 42 |
| view | 86 | menu | 64, 100 |
| Decommissioning | 97 | Installation | 19 |
| Delay (alarm) | 71 | Integral time | 76 |
| Des input | 35 | Intervall (Add-on Datalog) | 85 |
| Desktop | 20, 59 | L | |
| Diagnosis file | 59, 100 | Language | 57 |
| save diagnosis file..... | 56 | Level | 108 |
| Differential time | 77 | Limits | 71, 107 |
| Digital input | | Load language | 55 |
| event message | 100 | Load settings | 51 |
| Dimensions | 15 | Lower limit | 107 |
| Display | 59 | Low water | 108 |
| Disposal | 97 | M | |
| Dosage check | 108 | Maintenance | 92 |
| E | | Manual mode | 33 |
| Eco-mode | 80 | mA out of range | 109 |
| Event help | 63, 101 | mA output | |
| Eventlog | 101 | 22 mA alarm | 87 |
| Event messages | 100, 101 | Measuring set-up | 19 |
| Event-related support | 63 | Memory | 51 |
| Ext. controller stop | 108 | Memory stop data logging | 111 |
| F | | Menu cal | 40 |
| Facilitating functions | 97 | Menu overview | 24 |

Index

| | | | |
|----------------------------------|--------|-------------------------------|--------|
| Modbus RTU | | SD card | 52 |
| how to read out data | 90 | SD card error | 110 |
| Mode (operation) | 33, 92 | Serial number | 64 |
| N | | Settings | |
| No appli | 110 | datalog | 84 |
| | | display | 59 |
| | | how to save | 52 |
| | | overview | 64 |
| | | store and load | 51 |
| O | | Software | |
| Operating hours | 64 | load | 54 |
| Operation | 20 | update | 97 |
| Operation mode | 33 | version | 64 |
| Out of measuring range | 107 | System functions | 57 |
| P | | | |
| pH input | 34 | T | |
| Popup messages | 110 | Temperature measurement | 37 |
| Pulspump / 2 Puls pumps | 77 | Test menu | 50, 98 |
| | | Text | 61 |
| R | | Time | 58 |
| Range (mA outputs) | 77 | Total Chlorine | 38 |
| Raw signals | 100 | Touch calibration | 61 |
| Restarting | 97 | Trouble-Shooting | 99 |
| Restoring factory settings | 99 | | |
| Run ORP | 45 | U | |
| | | Upper limit | 71 |
| S | | | |
| Save | | V | |
| diagnosis file | 64 | View | 100 |
| settings | 61 | | |

Trouble-Shooting 99

U

Upper limit..... 71

V

View 100

 raw signals 64

W

Warranty 8

Z

Zeropoint101

Zoom (mA output) 87





Kuntze Instruments GmbH
Robert-Bosch-Str. 7a
40668 Meerbusch | Germany

+49 2150 70660
info@kuntze.com
www.kuntze.com

Version 2019/04