

Manual

K 100 CM & K 100 W CM K 100 IL & K 100 W IL

Measuring and control instruments
for conductivity measurements





DR. A. KUNTZE

GUTES WASSER MIT SYSTEM

Dr. A. Kuntze GmbH

Robert-Bosch-Str. 7a

D-40668 Meerbusch

Tel. +49-21 50-70 66-0

Fax +49-21 50-70 66-60

info@kuntze.com

www.kuntze.com

Contents

1. Your K 100	4
1.1 General and Safety instructions	5
1.2 Application	6
1.3 Intended use	6
1.4 Features	7
1.5 Technical data	8
1.6 Declaration of conformity	9
2. Instructions for installation and connections	10
2.1 Dimensions	11
2.2 Installation K 100	12
2.3 Installation K 100 W	13
2.4 Connection diagram K 100	14
2.5 Connection diagram K 100 W	15
3. Operation of the instrument	16
3.1 How to adjust parameters	17
3.2 Where to look for information	18
3.3 Menu overview	19
4. Code and language	20
5. Adjustments for the measurement	21
5.1 Measuring range and cell factor	22
5.2 Cable compensation and averaging	23
5.3 Temperature compensation	24
6. Adjustment of the controller	25
6.1 ON/OFF controller	26
6.2 P / PI controller as impulse-frequency controller	27
6.3 P / PI controller as pulse-pause controller	28
6.4 Activation and deactivation of the controller	29
6.5 Turn-on delay	29
6.6 External controller stop (digital input)	29
6.7 Manual operation of the relays	30
6.8 Dosage check	31
7. Data output	32
7.1 Current output	32
7.2 Current output as controller output	32
7.3 Serial interface RS485 (option)	32
8. Limit values and Alarm	33
8.1 Alarm	34
8.2 Configuration of the alarm relay	35
8.3 Error messages	36
9. Operation and maintenance	37
10. Service	39
Index	40
Customer settings - for reference!	42

1. Your K 100

Is an instrument by Dr. A. Kuntze GmbH which offers high quality and reliability for years.

It is one of our economy series K 100 with which we are trying to meet the rising demand for low cost / high end instrumentation.

The K 100 instruments are defined by an excellent value for money. They were developed to maximize functionality on standard applications. Nevertheless, the K100 offers a variety of adjustments to obtain highest accuracy.

Select from a variety of measuring ranges from $\mu\text{s/cm}$ to s/cm . The lowest measuring range can alternatively be displayed in $\text{M}\Omega/\text{cm}$. In addition to temperature compensation, less obvious influences such as cable capacitance or deviations caused by cell dimensions or ageing effects can be compensated.

All K 100 instruments have an integrated controller which provides bidirectional PI control, via two relays or as a steady-state controller via the analog output. You can define a turn-on delay to prevent incorrect dosage after power failure and operate the controller by remote control. Connect a level sensor, and the fail-safe will shut down the controller automatically in a low water situation. Activate the dosage check function to get an alarm if dosage achieves no results, indicating damages in the feeding lines.

New: Now you can configure the alarm relay as NO or NC, so that power failure gives an alarm, too, and as pulse contact instead of permanent contact, to fit all kinds of subsequent security systems. Furthermore, input errors and low water are now indicated via analog output in addition to the relay/display indication.

Let's not forget the alarm function with minimum and maximum limit and turn-on delay...

You have certainly made a good choice. On the following pages you learn more about your K 100. If, however, you have further questions or are looking for information not included in this manual or if you are interested in supplementing products like sensors or flow cells or in our other instrument series, just give us a call - we will be delighted to help you!

1.1 General and Safety instructions

This manual applies to the following instruments:

Instrument and type	Revision date
K 100 CM, K 100 W CM	11/10
K 100 IL, K 100 W IL	11/10

It contains technical information for the installation, start-up and maintenance. If you have any questions not included in this manual please contact your supplier or the official representative of Dr. A. Kuntze GmbH in your country.

We would like to point out that the warranties specified in our general trading conditions are valid only if

- installation, connections, adjustments, start-up, and maintenance of the instrument are carried out by authorized personnel with adequate qualification.
- the instrument is used according to the description in this manual.

Please check for damages immediately after receiving the instruments and report any damages within 24 hours to the delivering company. Never work with a damaged instrument.

Keep this manual at a safe place where you can always look up the safety instructions and the informations on handling and usage. According to DIN 61010 the manual is part of the product and must be maintained as long as the instrument is used, and given to the next owner if the instrument is sold.

This instrument was designed and built according to the safety measurements for electronic devices and has left our company in perfect working condition. To preserve this condition and to ensure safe usage follow all instructions carefully and pay special attention to all warnings issued in this manual. If the instrument is visibly damaged or has been stored inappropriately or if there are any doubts concerning safe usage, shut it down and make sure it cannot be restarted by accident.

You will notice that important safety instructions are highlighted:

- WARNING** highlights instructions for the protection of people. Disregarding these instructions may cause accidents and injuries!
- ATTENTION** highlights instructions for the protection of the instrument and the equipment. Disregarding these instructions may lead to damage or destruction of the instrument or equipment!
- NOTE** is used to highlight interesting details.

1.2 Application

The instruments K 100 (W) CM and K 100 (W) IL are used to measure the electrolytic conductivity in water and aqueous solutions. K 100 (W) CM instruments work with conductive sensors, K 100 (W) IL instruments work with inductive sensors. All have an integrated controller with two set points. With this you can control actuators such as dosing pumps or valves to add chemicals or fresh water until the desired conductivity is reached and maintained.

Applications are washing processes, surveillance of ion exchangers, desalination of cooling water, and concentration measurements for acidic or caustic solutions.

While the controller is set to Automatic, it controls independently the dosing of possibly hazardous chemicals, according to the measured values.

For safety measures, the measuring inputs are checked for failure. Failures are indicated in the display and via the alarm relay, which can set off a horn or lamp or relate to a central control. If that failure makes control unreliable, the controller is automatically switched off until the failure has been taken care of.

CAUTION **The instrument checks the input signals and the water flow, if a flow sensor is connected. It cannot detect erroneous settings or failures in the treatment system, nor can it check for plausibility! The safety of the system of which the instrument is part of, lies within the reach of responsibility of whoever built the system.**

1.3 Intended use

Use these instruments only for the monitoring and control of water.

Use only sensors, fittings, and accessories of Dr. A. Kuntze, since instruments and sensors are attuned.

Ensure that the required measuring conditions are constantly maintained, such as flow, pressure, temperature, etc.

Set-up the instrument according to this manual. Carry out all the steps described, and check all measurements and settings before you activate the controller.

Use all available safety measures such as the alarm relay, the dosage check, and the low water indication.

Regularly check that all safety measures are in good working order.

CAUTION **The protection built into the instrument is impaired if they are not used as intended!**

1.4 Features

Meter

Measuring ranges conductive	0 - 20.00 M Ω	(C = 0.05)
	0 - 2.000 μ S/cm	(C = 0.05)
	0 - 20.00 μ S/cm	(C = 0.05)
	0 - 200.0 μ S/cm	(C = 0.05)
	0 - 2.000 mS/cm	(C = 0.2)
	0 - 20.00 mS/cm	(C = 1)
	0 - 200.0 mS/cm	(C = 10)
Measuring ranges inductive	0 - 2.000 mS/cm	
	0 - 20.00 mS/cm	
	0 - 200.0 mS/cm	
	0 - 2000 mS/cm	
	-30.0 - 140.0 $^{\circ}$ C	
Display	Measured value and temperature with dimension Status display sensor, controller & alarm	
Temperature compensation	manual or automatic with Pt100 (CM) or NTC (IL)	
Temperature coefficient	0.0 - 8.0 %/K adjustable, non-linear compensation for pure water	



Controller

Set points	2 set points with adjustable direction
Controller types	ON/OFF controller with hysteresis P or PI controller as pulse-pause-, impulse-frequency- or steady controller
Hysteresis	adjustable within the measuring range
P range X_p	adjustable within the measuring range
Integral time T_N	0 - 2000 sec.
Least pulse	0.1 - 9.9 sec.
Pulse+Pause time	02 - 99 sec.
Impulse frequency	100 - 7200 pulses/h
Turn-on delay	0 - 200 sec.
Dosage check	0 - 90 min
Alarm function	min. and max. limit and onset delay

Connections

Relays	3 potential-free contacts (2x controller, 1x alarm) 6 A, 250 V, max. 550 VA
Analog output	0/4-20 mA galvanically isolated, max. load 500 Ohm
Analog inputs	1 measuring input for conductivity 1 measuring input for temperature sensor
Digital input	external controller stop or low water indication NC or NO selectable via menu
Serial interface (Option)	RS485, Baud rate 9600, data format 8Bit, 1start and 1stop bit, no parity

1.5 Technical data

Feature	K 100	K 100 W
view		
Installation	panel-type housing	wall-mounting housing
Dimensions	96 x 96 x 135 mm (WxHxD)	165 x 160 x 85 mm
Weight	0.8 kg	1.0 kg
Terminals	screw terminals for cables up to 1.5mm ²	spring-loaded terminals for cables up to 1.5mm ²
Protection class	Front IP54	IP65
Power supply	230 V +/-10%, 40..60 Hz, optionally 117 V or 24 V	
internal fuse	none	230V: 63mA HRC 117V: 125mA HRC 24V: 800mA NRC
Power consumption	10VA	
Contact rating	6 A / 250 V, max. 550 VA resistive load (with RC protective circuit)	
Operation temperature	0 - 50°C	
Storage temperature	-20 - +65°C	
Humidity	max. 90% at 40°C non condensing	

1.6 Declaration of conformity

EC Declaration of Conformity



DR. A. KUNTZE
GUTES WASSER MIT SYSTEM

40668 Meerbusch-Lank

Robert-Bosch Str. 7a
Tel. (02150) 7066-0 Fax (02150) 706660
e-mail info@kuntze.com www.kuntze.com

ISO 9001

Hereby we declare that our instruments:

K 100

are in conformity with the following directives:
2004/108/EC – Electromagnetic Compatibility directive (EMC)
2006/95/EC - Low voltage directive (LVD)

As long as the instructions for installation and set-up are observed.

The CE label was affixed in accordance with the technical harmonisation directive 2004/108/EC of the European Council dating from 15.12.2004.

Applied standards:

- EN 61000 6-1(3), VDE 0839 Part 6-1(3): 2002 (residential environment)
- EN 61000 6-2(4), VDE 0839 Part 6-2(4): 2006 (industrial environment)
- EN 61326-1: 2006, VDE 0843-20-1: 2006 Electrical equipment for measurement, control and laboratory use- EMC requirements
- EN 61010-1 :2002-08 Safety requirements for electrical equipment for measurement, control, and laboratory use

Meerbusch, 07.04.2009

.....
Dipl.- Ing. Christoph Scheffold
Managing Director



2. Instructions for installation and connections

Installation:

On the next pages you will find detailed instructions for the installation.

For panel-type meters you have to prepare an opening of 92x92mm. Install the instrument and fix it with the two mounting clips which were part of the delivery.

You can install instruments in wall-mounting housings either by hanging them upon the center slot or by sliding the slot under a screw, which is an alternative for limited space. Either way you have to fix it additionally with two screws.

ATTENTION Install the instrument in a place where it is not put under mechanical or chemical strain!

Mind the protection class:

K 100: Front IP54

K 100 W: IP65 (closed terminal cover)

Connections:

You will find detailed connection diagrams on the following pages.

Before connecting the power supply check the information on the instrument label!

ATTENTION Input, output and control lines must be installed separate from each other and separate from power lines!

For inputs and outputs use screened lines and connect the screen on one side only.

The measurements are interference-sensitive. Always use the special screened cables delivered with the sensors.

For the connection of temperature sensors use a low-resistance cable with a large diameter.

When using the relays, mind that with inductive loads, interference must be suppressed. If that is not possible, the relay must be protected at the terminal block in the K 100 by a resistance-capacitance filter or, in case of direct current, by a free-wheeling diode.

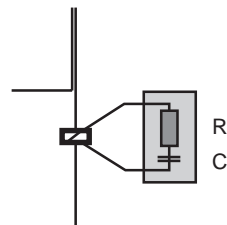

Current up to	Capacitor C	Resistance R
60 mA	10 nF 260 V	390 Ohm 2 Watt
70 mA	47 nF 260 V	22 Ohm 2 Watt
150 mA	100 nF 260 V	47 Ohm 2 Watt
1,0 A	220 nF 260 V	47 Ohm 2 Watt

2.1 Dimensions

K 100

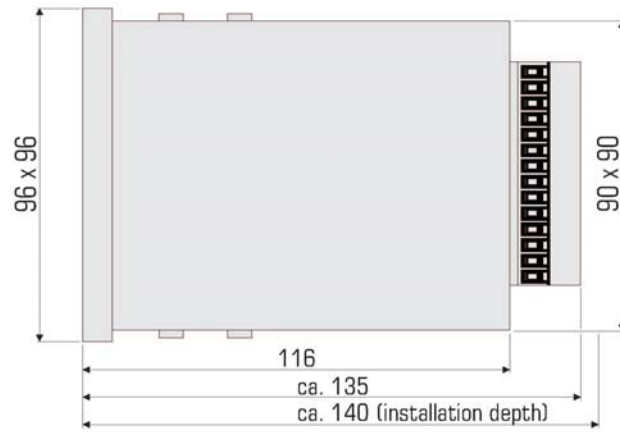

K 100 W

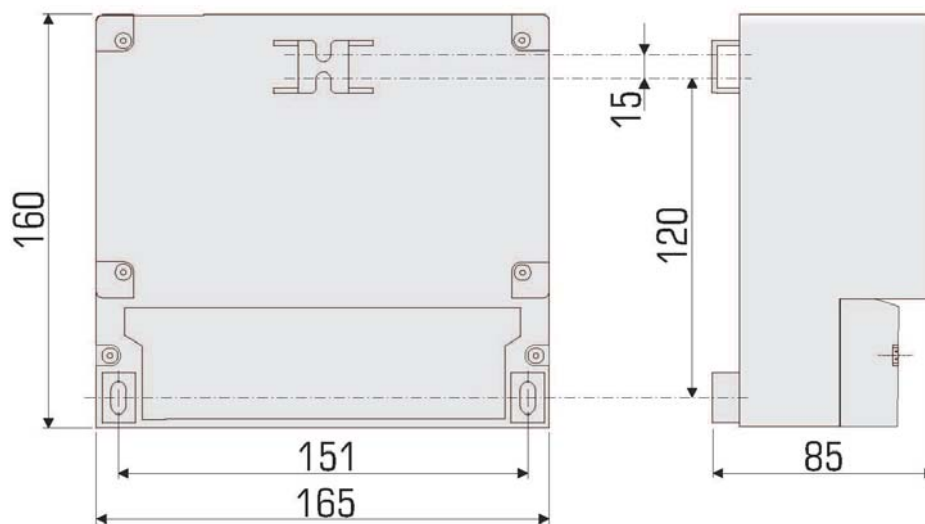

2.2 Installation K 100

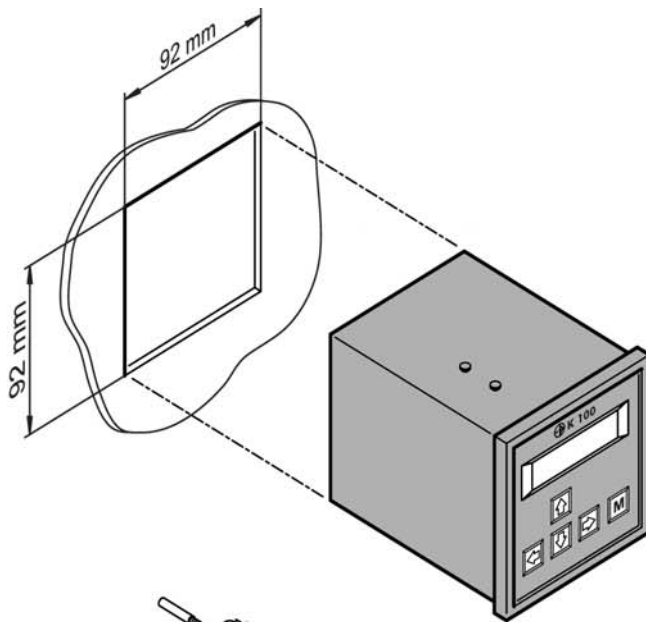

Prepare an opening of 92 x 92 mm.

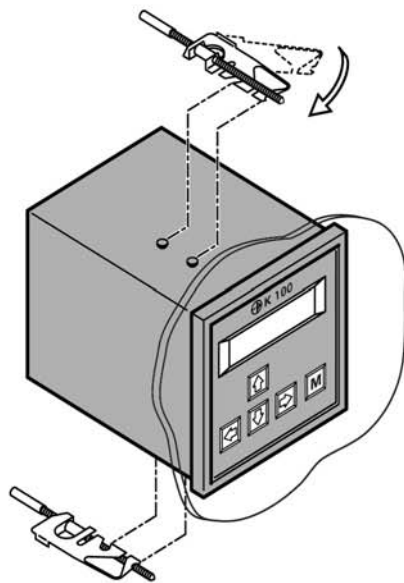

Install the instrument from the front side and fix it with the two mounting clips which were part of the delivery.

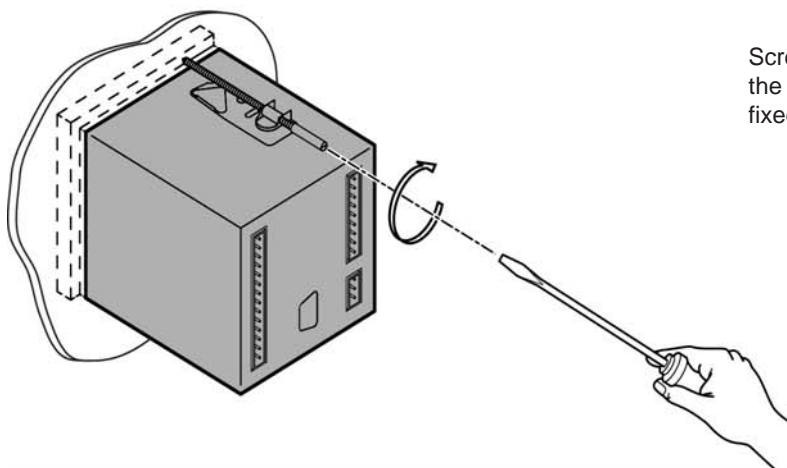

Screw tight until the instrument is fixed perfectly.

2.3 Installation K 100 W

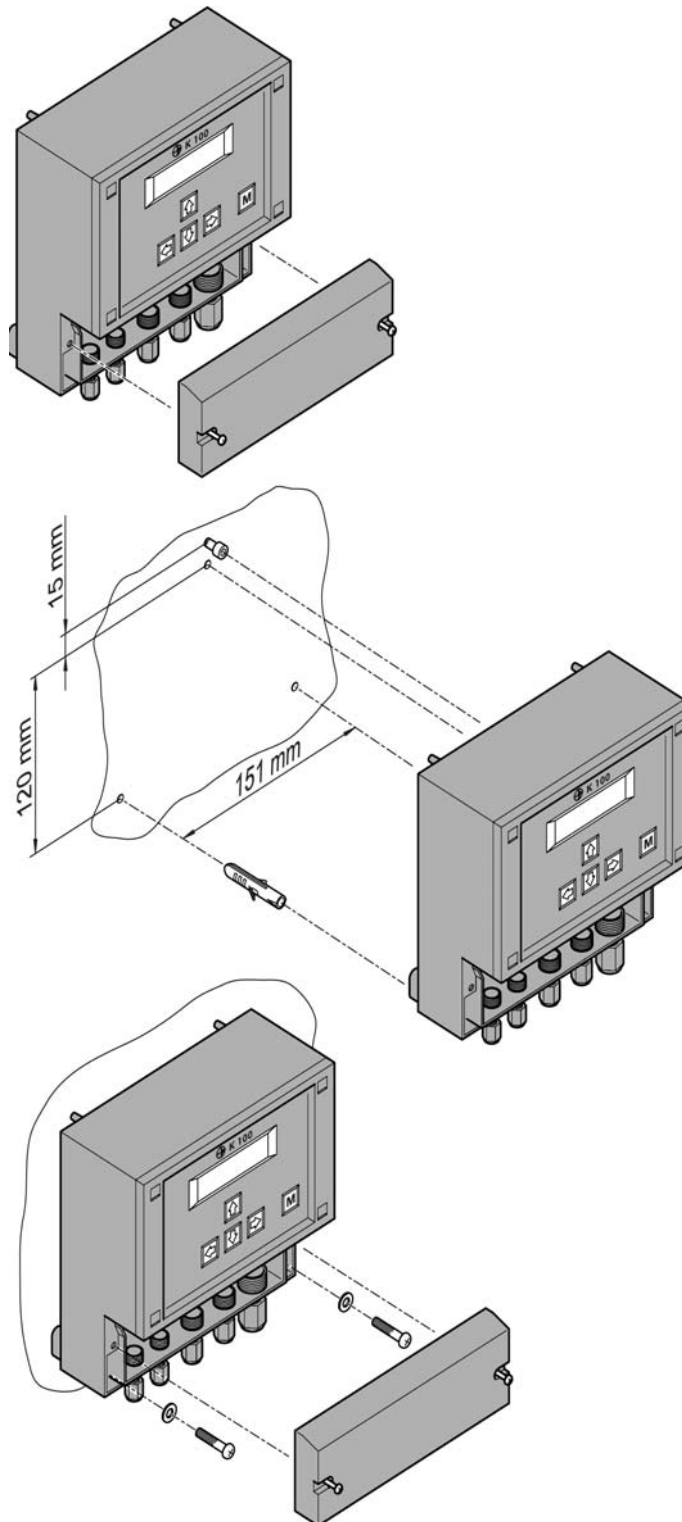

Remove the terminal cover.

Drill three holes (max. M5) according to the drawing. Mind that there are two ways for installation: (1) You can hang the instrument upon the upper screw. In that case drill the upper hole 120mm above the lower two. (2) Or you can slip the fixture on the back of the instrument under the upper screw. In that case the upper hole has to be another 15mm higher.

Mount the instrument and fix it with the two lower screws. Close the terminal cover or start with the connections.

2.4 Connection diagram K 100

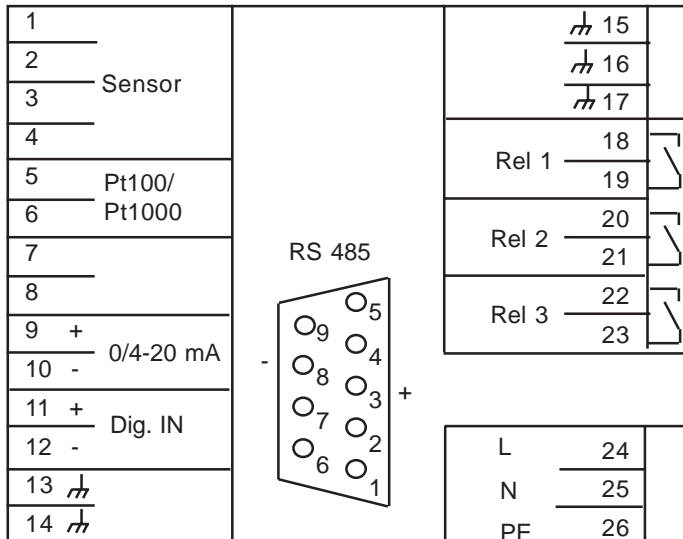
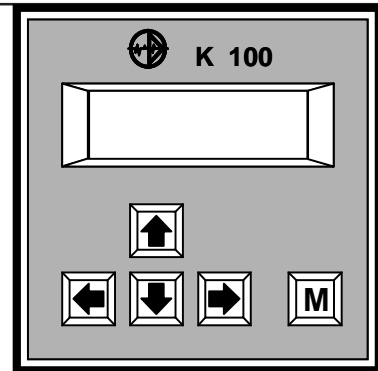

Connection	Terminals	Note
Conductivity sensor - conductive (CM)	2 + 3	2 = Inner electrode = white 3 = outer electrode = brown
	5 + 6	integrated Pt100 = yellow & green
- inductive (IL)	1 - 4	Measurement: green & white & screen 1 = green, 2 = white & screen Voltage supply = black & red 3 = black, 4 = red
	5 + 6	integrated NTC = yellow & brown 5 = yellow, 6 = brown
	Pt100 (CM)/ NTC (IL)	5 + 6
Analog output	9 + 10	9 = +, 10 = -, max. load 500 Ohm
Digital input	11 + 12	11 = +, 12 = -, external controller stop and / or low water indication
Relay 1	18 + 19	
Relay 2	20 + 21	
Relay 3	22 + 23	Alarm relay
Power supply	24 - 26	Check information on instrument label!
RS485 (Option)	Sub-D	3 = +, 8 = - 4/7 bridged activates terminating resistance

2.5 Connection diagram K 100 W

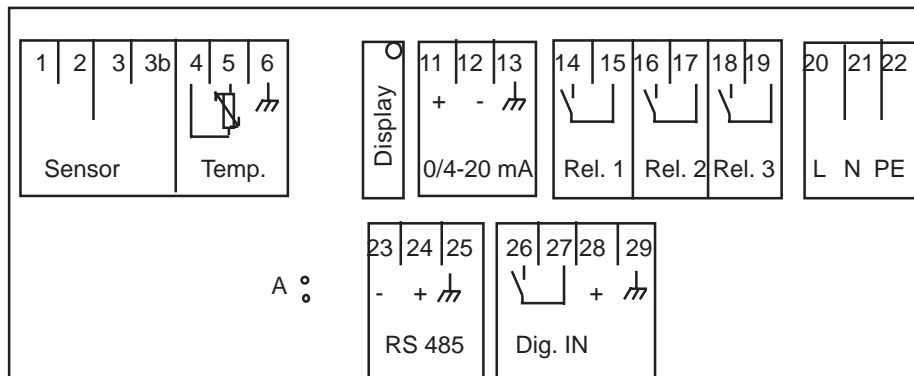
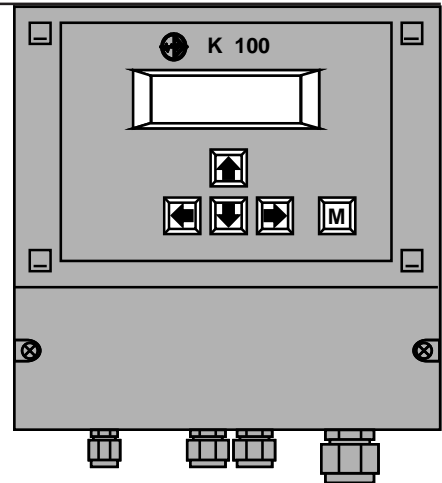

Connection	Terminals	Notes
Conductivity sensor - conductive (CM)	1 + 2	1 = Inner electrode = white 2 = outer electrode = brown
	4 + 5	integrated Pt100 = green & yellow
- inductive (IL15NTC)	1 - 3b	Measurement = green & white & screen 1 = green, 2 = white & screen Voltage supply = red & black 3 = red, 3b = black
	4 + 5	integrated NTC = yellow & brown 4 = yellow, 5 = brown
Pt100 (CM) / NTC	4 + 5	
Display contrast	Display	Potentiometer to adjust brightness
Analog output	11 + 12	11 = +, 12 = -, max. load 500 Ohm
Relay 1	14 + 15	
Relay 2	16 + 17	
Relay 3	18 + 19	Alarm-Relais
Power supply	20 - 22	Check information on instrument label!
RS485 (Option)	23 + 24	23 = -, 24 = + Jumper A activates terminating resistance
Digital input	26 + 27	26 = +, 27 = -, external controller stop and / or low water indication
	28	24 V DC for inductive contact

3. Operation of the instrument

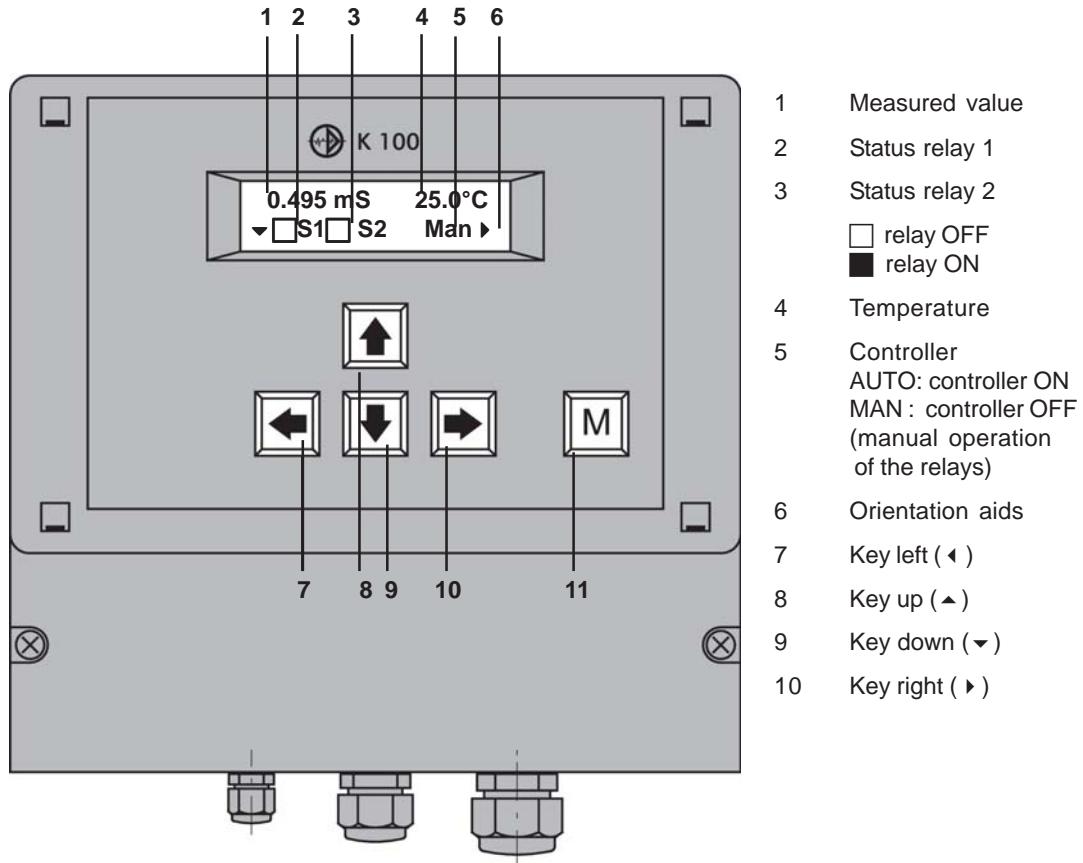

When turned on the instrument shows the measured value and temperature together with the controller mode (Man) and the status of the relays S1 and S2 (both OFF).

With five membrane keys you can move within the menu:

With key ▼ you enter the main menu.

With keys ▲ and ▼ you move up and down in the menu.

With key ▶ you address a menu or parameter.

With key ◀ you leave a menu or store a change.

For your convenience triangles in the display indicate the directions you can take from your position in the menu.

With key „M“ you get back to the display of the measured values from any point in the menu. Changes that have not been stored will be lost.

From the display of the measured values you can switch the controller ON and OFF with key ▶ in the order: AUTO ▶ HOLD ▶ MAN ▶ AUTO.

NOTE The instruments K 100 and K 100 W differ only in the enclosures. Operation and menus are the same.

3.1 How to adjust parameters

Temp. Comp.
▶ Manual Comp.

1) When you address a parameter the actual setting is displayed.

Temp. Comp.
▶ Automat. Comp.

2) Switch to the next alternative setting with key ▶ .

Temp. Comp.
▶ Manual Comp.

3) When you have come to the last alternative, pressing the key once more will bring you back to the start.

Selection between alternatives

For many parameters you have the choice between two or more alternatives, e. g. between manual and automatic temperature compensation. For these parameters you need only key ▶ . Switch from one alternative to the next until you either come back to where you started or until you reach the alternative you were looking for.

With these parameters any changes are immediately valid - there is no need to store the change.

Enter code
▶ 058 Code

1) Address the parameter with key ▶ .

Enter code
◀ 058 ⇄ Code

2) A double triangle appears behind the number indicating that the number can be changed now with keys ▲ and ▼ .

Enter code
▶ 062 Code

3) Store the new value with key ◀ . The double triangle disappears - the new value is stored.

Adjustment of numerical parameters

Numerical parameters can only be altered when a double triangle is visible behind the number. This double triangle appears when you address the parameter with key ▶ .

Adjust the parameter with keys ▲ and ▼ . A short pressure on the key changes the last decimal by 1. If you keep the key pressed, the value will continue changing until the pressure is released.

Store the changes with key ◀ . The double triangle disappears.

NOTE If you do not want to store the change, press key „M“ instead of key ◀ .

3.2 Where to look for information

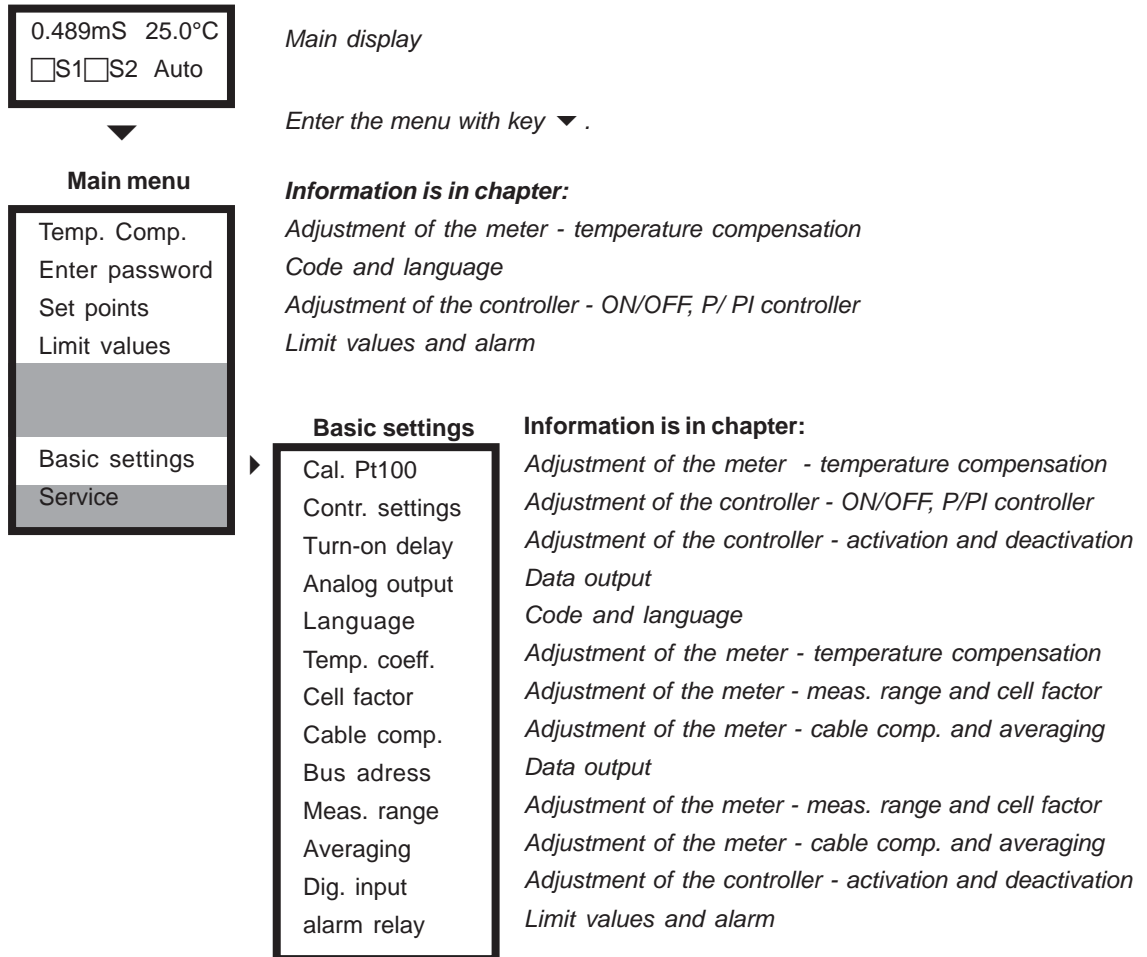

Main menu and basic settings

The parameters are sorted into two menus: In the main menu you will find all functions which are used regularly, such as calibration. The menu basic settings contains all parameters which are set just once during start-up.

On the following pages you will find information on how to adjust parameters and which parameters you need for which application, in the following order:

- 1) General adjustments: password and language
- 2) Adjustments for measurement: Measuring range, cell factor, cable and temperature compensation, averaging (for the lower ranges)
- 3) Adjustments of the controller: selection of the controller version and corresponding parameters
- 4) Adjustments to read out data: analog, digitally and/or as alarm

3.3 Menu overview

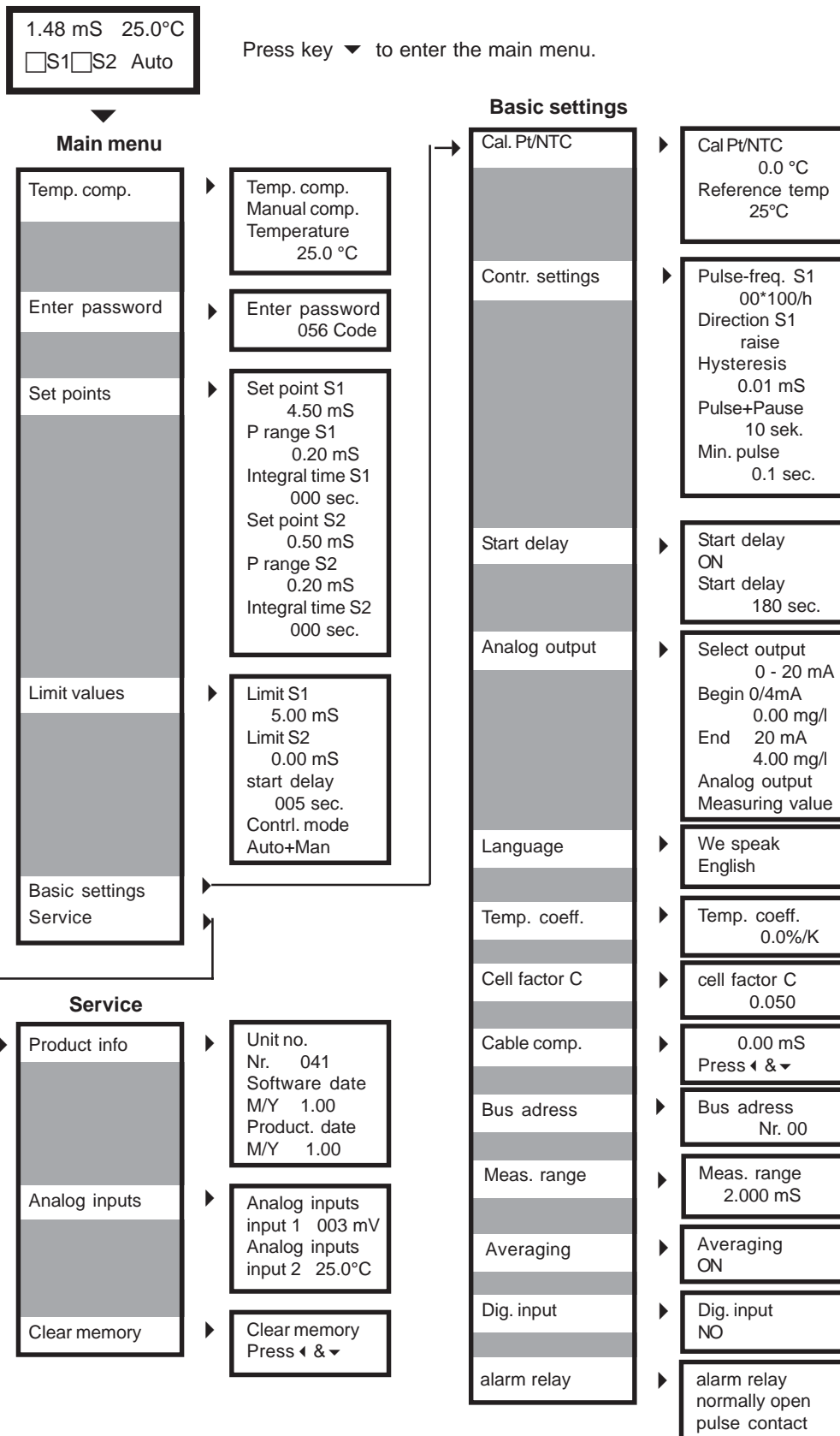

4. Code and language

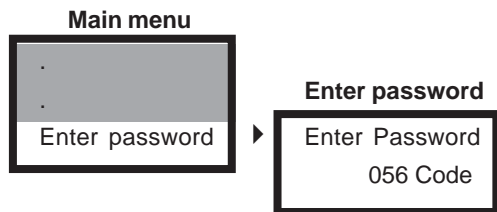

Enter password

To get access to the various parameters you have to enter the correct password:

Code 11 gives access to the parameters of the main menu.

Code 86 gives access to all parameters and functions.

With any other number it is impossible to select, view or change any parameter.

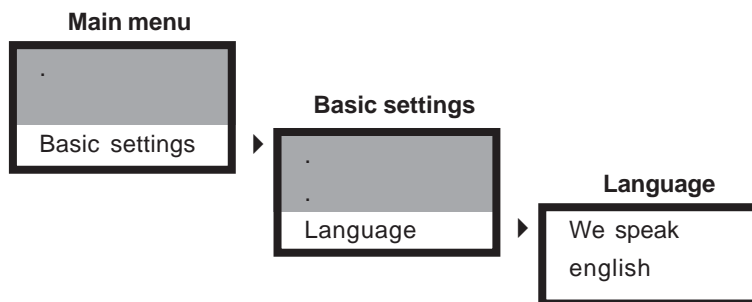

Language

For the communication with the instrument you can choose from a variety of languages.

Since choosing a language is part of the basic settings, it requires code 86. If a different code is set, you will be asked to enter the correct password.

5. Adjustments for the measurement

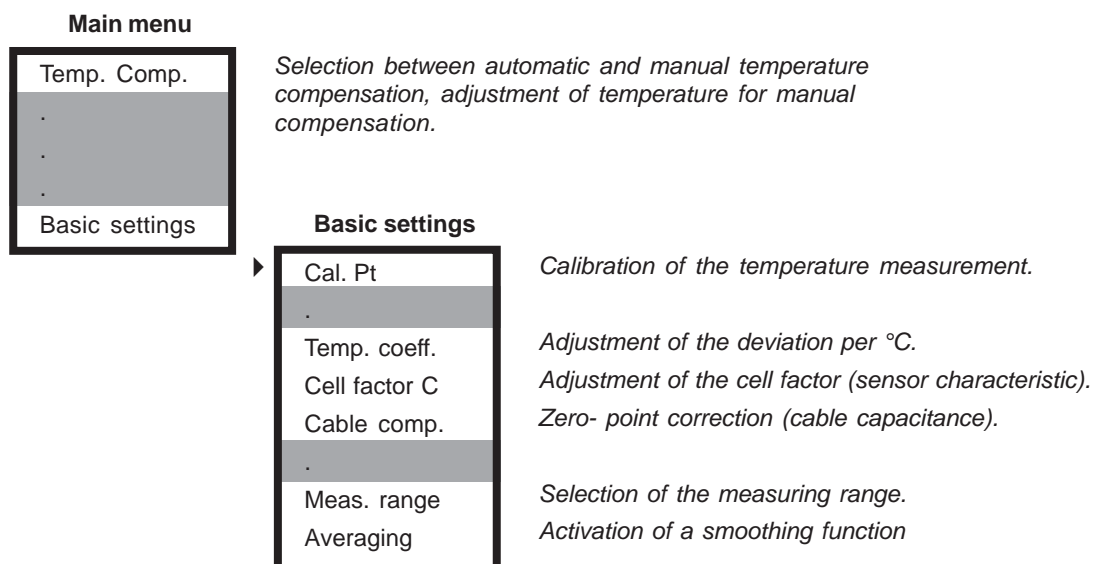

First choose the desired measuring range. Adjust the cell factor - it is indicated on the sensor. The cell factor accounts for the geometrical design of the sensor and allows to standardise the measured values.

The conductivity measurement is influenced by temperature. This influence is compensated automatically or manually. For manual compensation the temperature is entered manually, for automatic compensation a temperature sensor must be connected. Compensation is carried out linearly using a temperature coefficient in %/°C which depends upon the composition of the test water.

The capacitance of the sensor cable can lead to a slight deviation of the measurement. This deviation can be eliminated by cable compensation.

Especially in the lower measuring ranges the measurement can be smoothed out by activating an averaging function.

All these adjustments are part of the basic settings, since they are carried out only once at the beginning.

5.1 Measuring range and cell factor

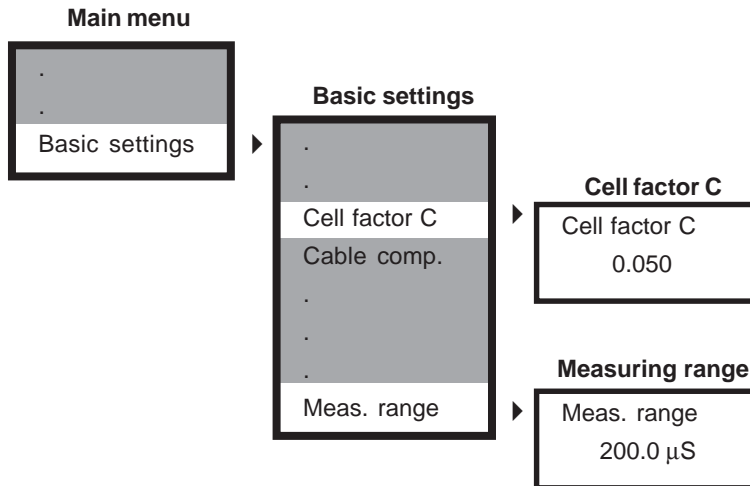

Measuring range

Select from a variety of measuring ranges reaching from $\mu\text{S}/\text{cm}$ to S/cm . In the lowest range you can also switch to $\text{M}\Omega$.

Cell factor (c-value)

Please make sure that the cell factor of the sensor is appropriate for the selected measuring range. In contrast to the instrument which can be used for all ranges, the sensor's applicability is limited by its geometrical design, i. e. the size and arrangement of its electrodes. The cell factor is the numerical expression of this design. With this cell factor the instrument can process the measurement and calculate standardised conductivity values.

The c value is a sensor characteristic. You will find it indicated on the sensor. With inductive sensors, the c value is already set.

Fine tuning via c-value

The cell factor of a sensor can change slightly due to pollution or aggressive cleaning. Especially with inductive sensors the c value is influenced by the dimensions of the flow cell. These deviations can be eliminated by determining the conductivity with a comparative method and adjusting the cell factor until the measured value displayed by the instrument equals this conductivity.

NOTE This fine tuning is only as good as the comparative method! Since it requires sophisticated equipment and some skills, we advise to do it only if the highest precision is required. Usually the errors caused by temperature measurement or inappropriate temperature coefficients are much higher than the deviations of the cell factor.

5.2 Cable compensation and averaging

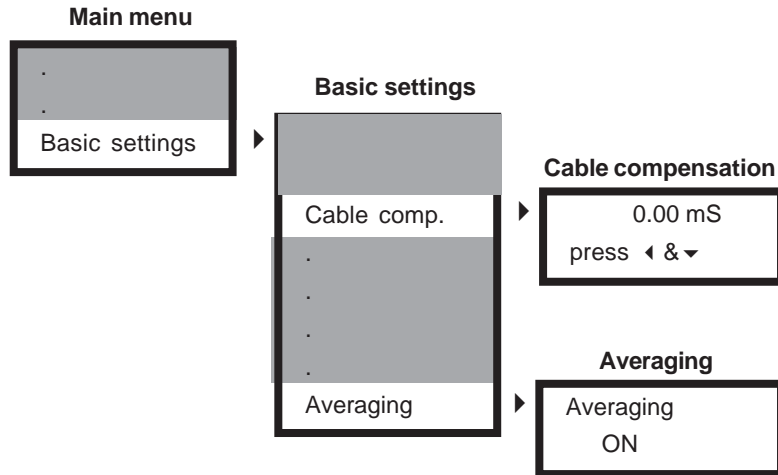

Cable compensation (Zero-point correction)

The cable connecting the sensor to the instrument can cause a capacitive error. To detect and eliminate this error, connect the sensor to the instrument and let the dry sensor hang free in the air. If the measured value displayed is not zero, then compensate by pressing keys ◀ and ▼. Now the value displayed is zero.

With inductive sensors, do not carry out cable compensation.

Averaging

Especially in the lower ranges the signal might become a bit unstable, due to the very high resistance of the solution. In that case you can smooth out the signal by averaging over subsequent measurements. When the averaging function is activated, the average is displayed instead of the single measured values.

5.3 Temperature compensation

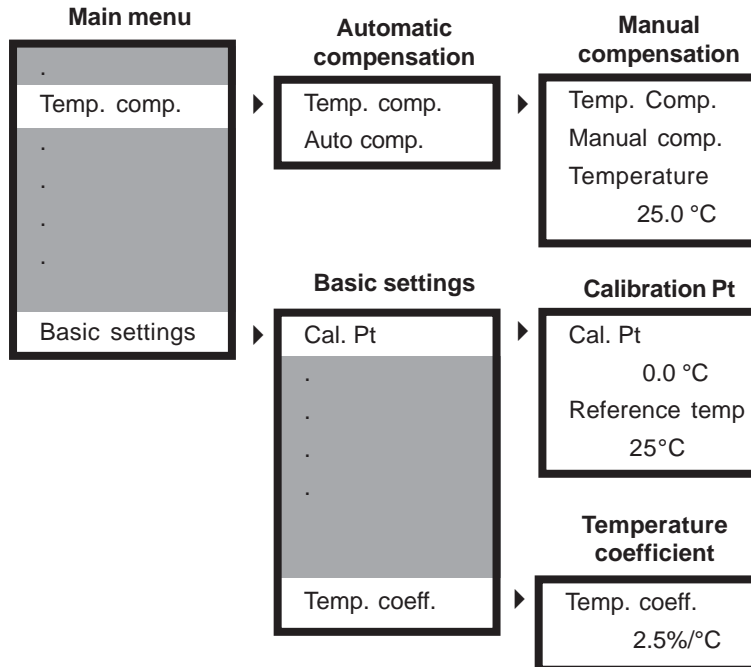

For automatic compensation you need a temperature sensor Pt100 (CM) or NTC (IL). All our conductivity sensors have integrated temperature sensors matching the instrument requirements.

If the temperature can be regarded as constant, you can enter the temperature manually instead of measuring it continuously. The instrument will then compensate the temperature error of this temperature.

Calibration of the temperature measurement

Check the temperature measurement in the beginning. If the displayed temperature differs from the real temperature, enter the deviation. This correction term will be added to all temperature measurements. If your calibration was correct, the temperature displayed is now equal to the real temperature.

Here you can also adjust the reference temperature for the compensation. All measured values are calculated to match this temperature. Usually, the reference temperature is 25°C.

Linear or pure-water compensation

The temperature influence on the conductivity depends upon the composition of the solution and often cannot be expressed by a simple equation. Usually, the temperature dependency is compensated using a linear coefficient given as deviation in % per °C. This coefficient increases with increasing resistance. For tap water a coefficient of 2.5%/°C can be used to good results. For ultra-pure water switch to the non-linear compensation.

6. Adjustment of the controller

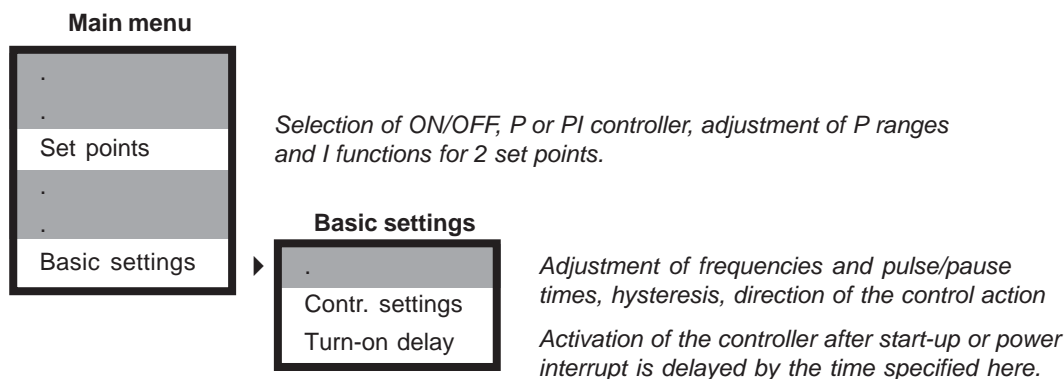

For any type of controller you have to enter one or two set points, and you have to tell the instrument whether these set points are reached by increasing or decreasing the measured value.

You can choose between three different controller versions:

ON/OFF controller

The ON/OFF controller switches ON if the measured value exceeds the set point and OFF if it drops back below it or vice versa. Dosage is always carried out with 100% (ON) or 0% (OFF). The parameter for an ON/OFF controller is the hysteresis.

P controller

The P controller or proportional controller reduces the dosage in the vicinity of the set point proportional to the control deviation. This is easily achieved if the analog output is used as steady control output. If the relays are used, the proportional reduction is achieved by either reducing the switch frequency (Impulse-frequency controller) or reducing the time within a given period of time in which the relay is ON (pulse-pause controller). The parameters for a P controller are the P range and the impulse-frequency or the pulse+pause time and the minimum pulse.

PI controller

The PI controller is a P controller with an additional I function. Adjustments and parameters are the same as for an P controller. Additionally the integral action time has to be adjusted which determines the I function. The I function eliminates the P controller's disadvantage of a remaining steady-state deviation.

6.1 ON/OFF controller

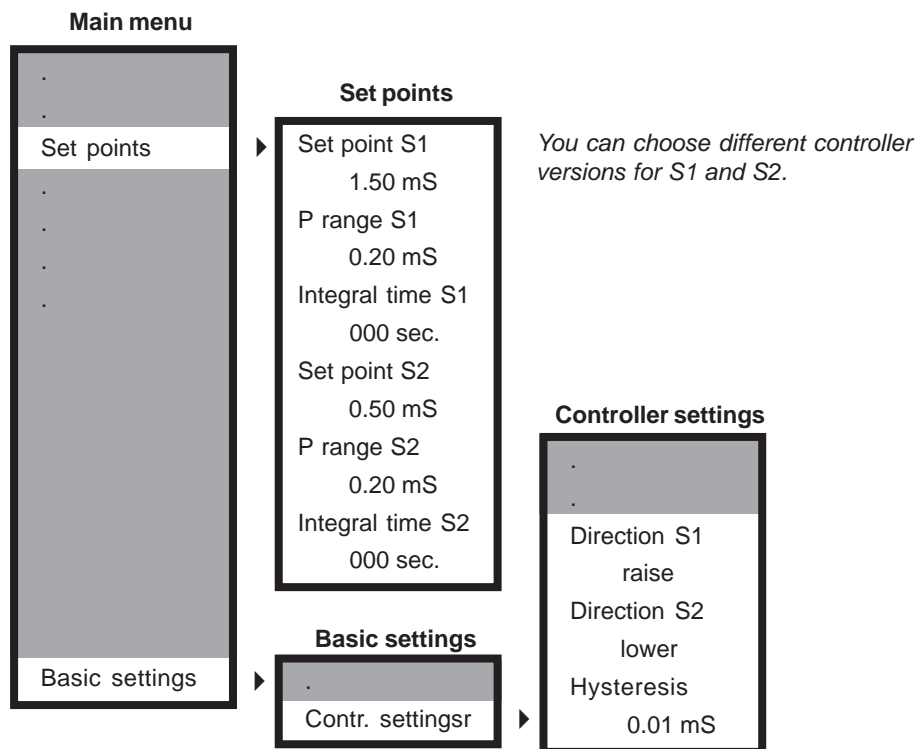

For an ON/OFF controller you have to set the following parameters:

1) Set points S1 and S2

Set point S1 refers to relay 1, set point S2 refers to relay 2.

2) P range and integral action time for S1 and S2

For an ON/OFF controller set P range = 0 and integral time = 0.

3) Acting direction for S1 and S2

Select „raise“ if the dosage raises the measured value.
Select „lower“ if the dosage lowers the measured value.

4) optionally a hysteresis

The hysteresis prevents fast switching in the vicinity of the set point. If hysteresis is activated (by setting a value > 0) the relay switches only when the set point is exceeded by half the hysteresis.

6.2 P / PI controller as impulse-frequency controller

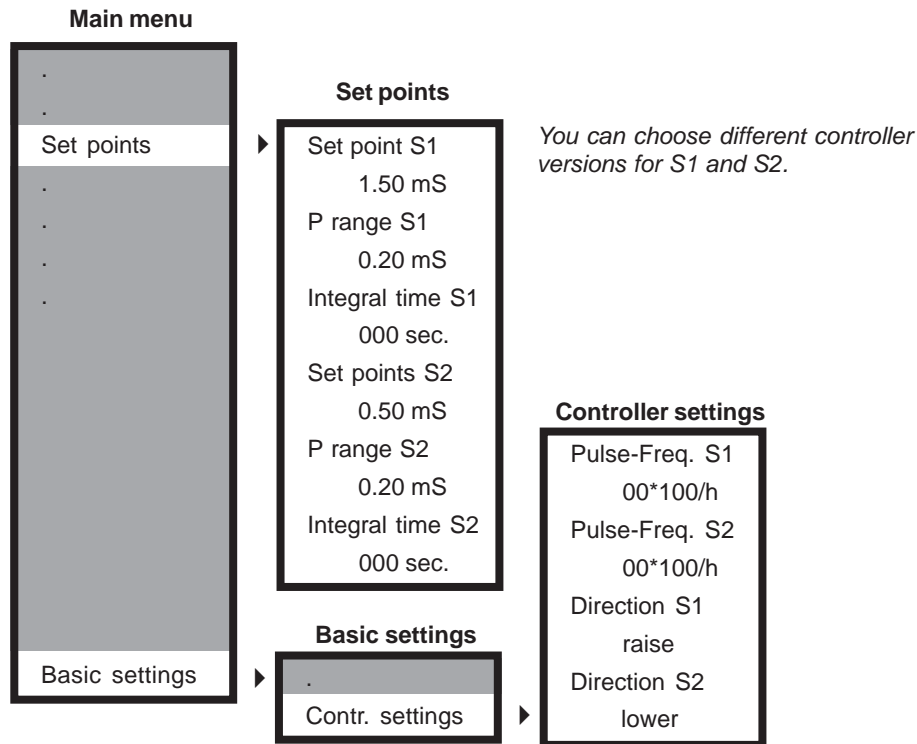

For an impulse-frequency controller you have to set the following parameters:

1) set points S1 and S2

S1 refers to relay 1, S2 refers to relay 2.

2) P range and integral action time for S1 and S2

Adjust a P range > 0. For a P controller set integral time = 0, for a PI controller set an integral time > 0.

3) pulse-frequencies for S1 and S2

Enter the maximum pulse-frequency that corresponds to 100% dosage.

4) the acting direction for S1 and S2

Select „raise“ if the dosage raises the measured value.
Select „lower“ if the dosage lowers the measured value.

6.3 P / PI controller as pulse-pause controller

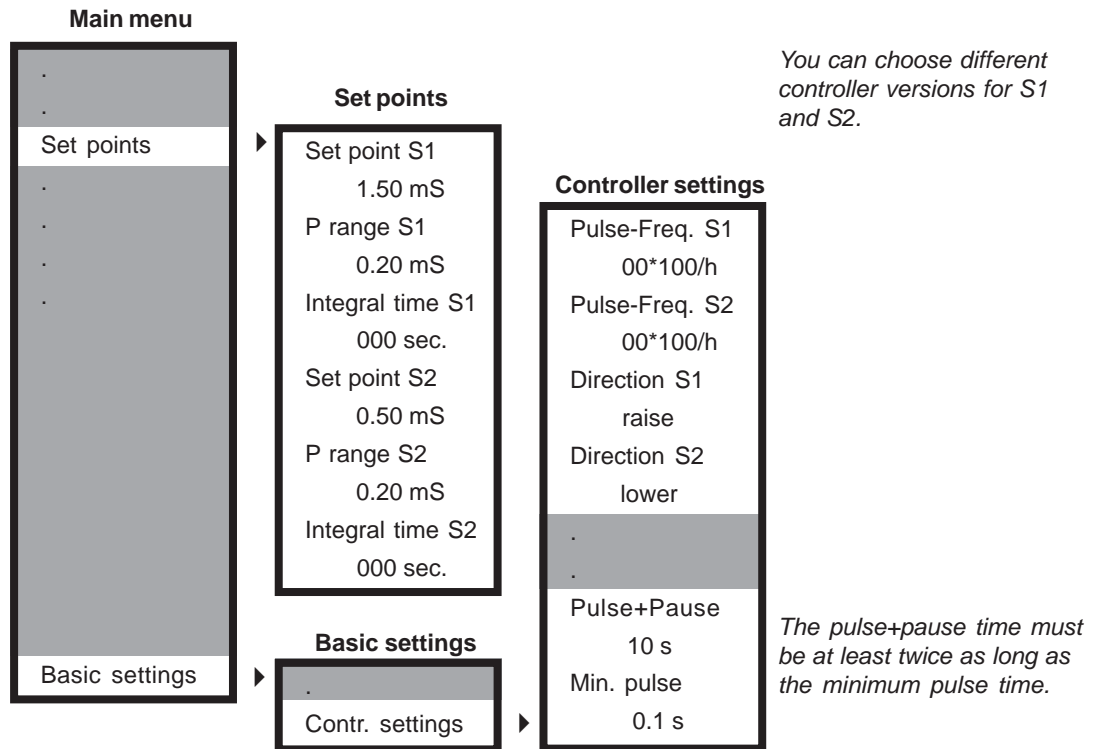

For a pulse-pause controller you have to set the following parameters:

1) set points S1 and S2

S1 refers to relay 1, S2 refers to relay 2.

2) P range and integral action time

Adjust a P range > 0. For a P controller set integral time = 0, for a PI controller set an integral time > 0.

3) pulse-frequencies for S1 and S2

Both frequencies must be set to 00, otherwise the controller will act as an impulse-frequency controller.

4) the acting direction for S1 and S2

Select „raise“ if the dosage raises the measured value.
Select „lower“ if the dosage lowers the measured value.

5) pulse+pause time

Define a period of time during which the relay is proportionally to the control deviation ON (pulse) or OFF (pause), respectively.

6) least pulse time

Set a minimum pulse time that the relay has to at least remain open to allow the actuator to react.

6.4 Activation and deactivation of the controller

You can activate and deactivate the controller without any menu. Press key ▶ to switch from manual operation (controller OFF) to automatic operation (controller ON) to HOLD (limit function deactivated, current output frozen) and back to manual operation. The actual operation mode is indicated in the display by MAN or AUTO.

WARNING Make sure that the controller is OFF when connecting dosing pumps or other actuators!

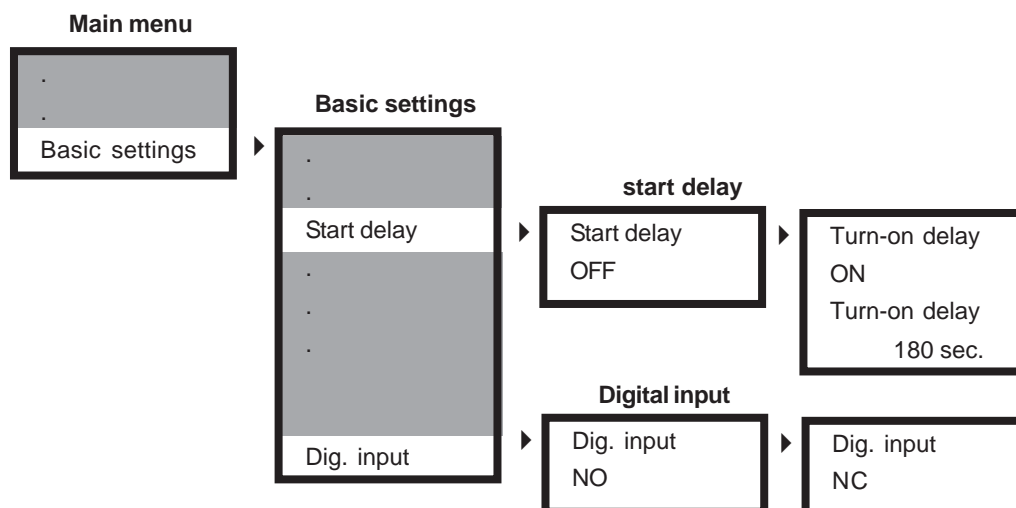

6.5 Turn-on delay

Set a delay time which has to pass before the controller is activated after start-up or power interrupt. This allows the measurement to settle and prevents inappropriate dosage of chemicals.

6.6 External controller stop (digital input)

You can activate or deactivate the controller with an external switch by using the digital input. This feature can also be used as low water indication. Just connect a level or flow sensor to the digital input. At works, the input ist NO (normally open). You can switch to NC (normally closed) in the basic settings.

With selection NO, the controller stops whenever the digital input is closed, with NC, it stops whenever the input is opened.

As long as that is the case, the message "external controller stop" is displayed.

6.7 Manual operation of the relays

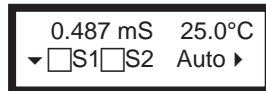

1) If the controller is ON, switch it OFF with key ▶ .

Instead of „Auto“ the display shows „Man“.

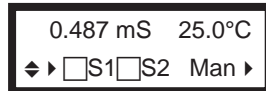

2) Switch to the operation mode of S1 with key ▲ .

The square to the left of S1 starts to flash.

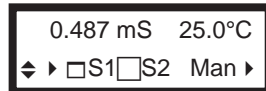

3) Switch ON relay 1 with key ▶ .

The square to the left of S1 gets dark.

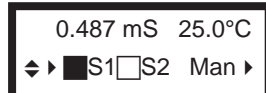

4) Switch OFF relay 1 again with key ▶ .

The square gets light.

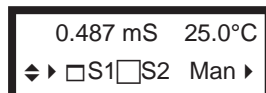

5) Switch to the operation mode of S2 with key ▲ .

The square to the left of S2 starts to flash.

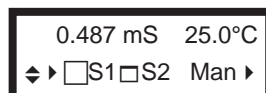

6) Switch ON relay 2 with key ▶ .

The square to the left of S2 gets dark.

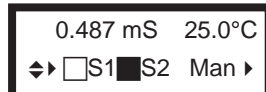

7) Switch OFF relay 2 again with key ▶ .

The square gets light.

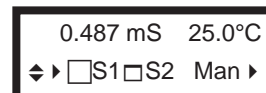

8) Leave the operation mode of relay 2 with key ▲ .

Both squares appear light, none flashes - You have left the operation mode.

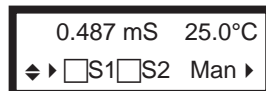

For manual operation you need no menu.

With key ▶ you switch OFF the controller.

With key ▲ you switch between Manual operation <> operation mode S1 <> operation mode S2 <> manual operation.

In the operation mode you can Switch ON and OFF the selected relay with key ▶ .

A flashing square indicates that the relay is in operation mode.

A dark square indicates that the relay is switched ON.

A light square indicates that the relay is switched OFF.

WARNING If you switch ON a relay it stays ON until you switch it OFF again manually!

6.8 Dosage check

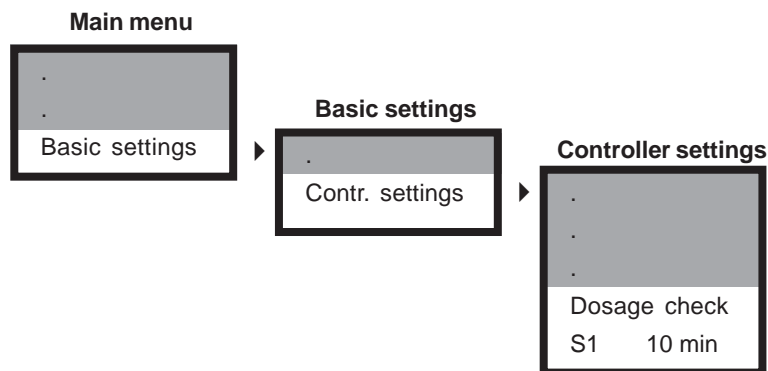

In the basic settings of the controller you can define, how long a controller is supposed to dose with 100% without raising alarm.

If the controller output is 100% for more than the specified time, this is interpreted as an indication of failure, and the instrument issues an alarm and deactivates the controller, thus stopping further dosage.

The dosage check is a safety catch to prevent hazardous chemicals to be set free in case of a defective dosing tube or tube connection.

NOTE In case of an alarm due to dosage check, only the controller concerned is deactivated.

NOTE If you set the dosage check time to 0 seconds, the dosage check function is deactivated.

7. Data output

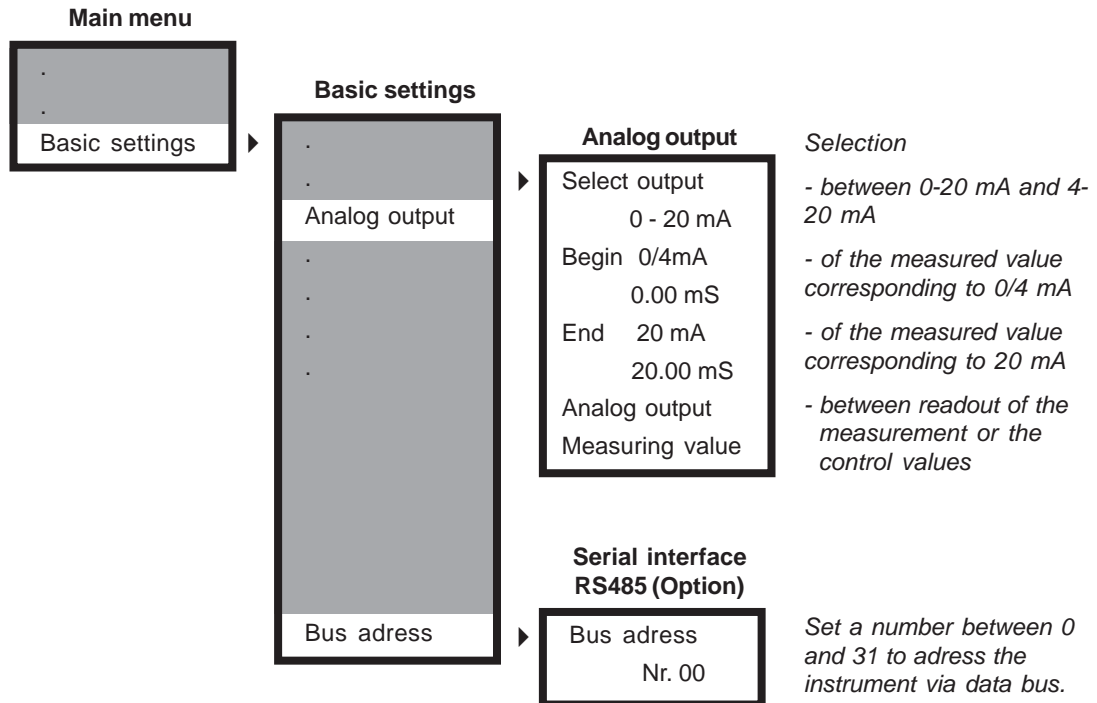

7.1 Current output

You can read out the measured values as 0/4-20 mA signals via the current output. With the setting 4-20 mA the resolution is lower, but defective cable connections are immediately evident.

With the parameters Begin and End you define which part of the measuring range you want to read out.

7.2 Current output as controller output

Alternatively you can use the current output as steady-state controller output. In that case assign the current output to the correcting variables S1 bzw. S2 instead of the measured value. The output will be in % - 100% equalling 20mA - so you do not have to define start and end values.

7.3 Serial interface RS485 (option)

The instruments are available with serial interface RS485 by means of which they can be integrated in a data bus system. Via the interface, all settings, measured and control values as well as any error messages can be read out digitally.

Instruments with RS485 are automatically delivered with the leaflet „Information on the RS485“ which contains instructions on the communication and a complete list of the functions available via interface.

8. Limit values and Alarm

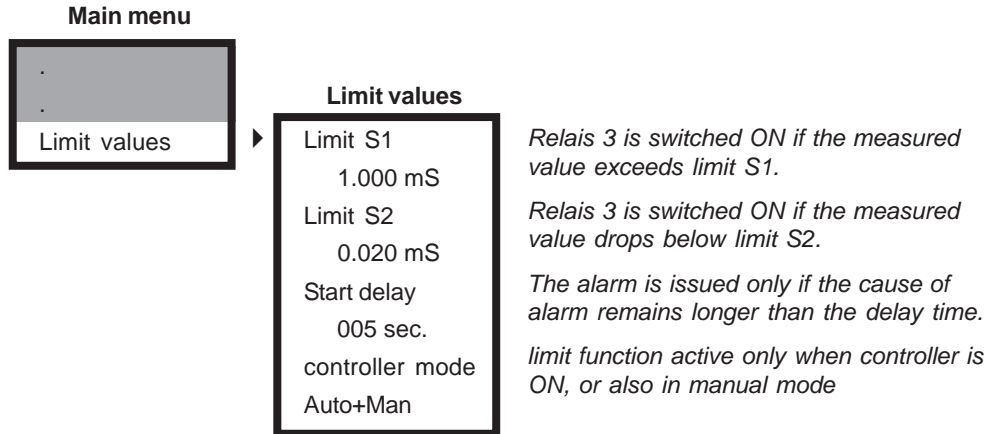

For the alarm, you can adjust two limits: limit 1 is an upper limit. If the measured value exceeds limit 1, an alarm is issued. Limit 2 is a lower limit. The alarm is issued if the measured value drops below limit 2.

In case of alarm the display shows the message „limit 1“ (or 2, respectively), and relay 3 is switched ON. This relay can be used to activate an external horn or lamp.

NEW! You decide whether the limit function is active only when the controller is set on automatic mode, or whether it should also be active in the manual mode.

NEW! If you are worried that in the latter case an alarm is issued during maintenance, please note that we have added a HOLD function which enables the limit values and freezes the analog output just for such contingencies. For more information, see chapter 9 - Operation and maintenance.

Start delay

In some applications it happens regularly that the measured value exceeds a limit for a short period of time. To avoid having an alarm issued under these circumstances you can adjust a start delay which has to pass before an alarm is issued. If the start delay time is >0 then the alarm is issued only if the cause of alarm remains longer than the specified delay time.

8.1 Alarm

Additional to the limit function the instrument provides various check functions that raise alarm. In case of alarm, the alarm relay switches, undelayed, and the cause of alarm is indicated in the display.

If the cause of alarm is such that control is no longer possible or might even be dangerous, the controller is automatically deactivated until the alarm is switched off. Switching off the alarm is done automatically by the instrument as soon as the cause of alarm is eliminated.

Failures connected with the measurement - input errors and low water - also lead to a current output of 0mA (only when assigned to the measurement).

Sensor check during measurement

During measurement all measuring inputs are checked. If an analog input does not receive a correct signal, an alarm is issued, and the controller deactivated. Alarm and controller stop remain until the analog input receives correct signals again. In case of an input error, the current output is set to 0mA.

Low water

If you connect a flow sensor to the digital input, in a low water situation the flow monitor will issue an alarm. The alarm remains until the flow monitor shows that water is again available. During the alarm the controller is deactivated, and the current output set to 0mA.

Dosage control

If a controller output is 100% for longer than the defined dosage time, an alarm is issued, and the corresponding controller is deactivated. The alarm remains until the controller output drops below 100%. It can also be extinguished by setting the controller to manual mode.

Cause of alarm	only active in AUTO mode	deactivates controller
Error input 1	no	yes
Error input 2 (T)	no	yes
Limit min/max	adjustable	no
Dosage check	yes	yes
Low water	no	yes

8.2 Configuration of the alarm relay

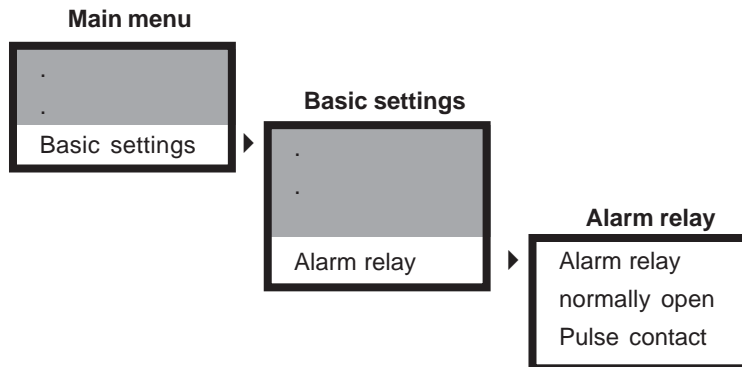

New: You decide whether the alarm relay should be a NO or NC contact. At works it is set to NO as it used to be. In the basic settings you can change to NC. In that case the relay is kept closed actively, so in case of power failure it opens, thus issuing an alarm.

NEW: You can also decide whether the relay should switch permanently during an alarm or whether it should only give a pulse. This allows independent acknowledgement of the alarm to shut off horns, for example. It also allows registration of subsequent alarms. At works the configuration is permanent contact, as it used to be.

8.3 Error messages

Error message	Cause	Measures
Error input 1	The measuring input receives no real signal.	Please check the connections, the cable and the sensor for signs of damage. This message also appears if the measuring range is exceeded.
Error input 2	The temperature sensor gives no signal.	Please check the connections, the cable and the sensor for signs of damage. This message also appears if automatic temperature compensation was selected although no temperature sensor was used or the sensor did not correspond to the settings.
Limit 1 / 2	The measured value exceeded limit 1 (or dropped below limit 2, respectively).	Please check the dosing and readjust the control parameters, if necessary.
Dosage check 1 / 2	Controller 1 (or 2, resp.) gives out a 100% output for more than the defined period of time.	Please check the dosing, especially the feeding tubes and connections. Caution! Carefully check for leaking chemicals!
Ext. controller stop	The digital input has been short-circuited.	This only indicates the external controller stop. If, however, you have connected a level sensor, this message appears due to the „low water“ alarm.

9. Operation and maintenance

Display contrast

With instruments in wall-mounting enclosures the display contrast can be adjusted to the actual light conditions by means of a potentiometer. It is indicated in the connection diagram with the word „display“.

Cleaning

The front and the display should not get in touch with organic solutions such as methanol. Never let water get inside the instrument. We suggest to simply use a damp cloth for cleaning.

Exchange fuse

WARNING! Disconnect the power supply before opening the instrument!

ATTENTION Mind that the cable connections to the front are not damaged, broken or torn during the process!

Instruments in wall-mounting enclosures have an internal fuse which has to be replaced at need. You will find a spare fuse fixed to the inside of the terminal cover. Information on the fuse can be found in the chapter „Technical data“.

To exchange the fuse, open the front carefully. The fuse is located in the lower right hand side. It is kept in place by a Bayonet lock. Turn the lock to the left until the fuse pops up. Exchange it and fix the new fuse by turning the lock to the right. Put the front back on and fix it tightly.

Maintenance of the safety functions

Regularly check the alarm relay to make sure that in case of failure both the indication by the instrument and the recognition by the superior control (SPS etc.) work reliably.

You can set off the alarm for example by setting limit S1 to a value smaller than the current measured value.

NOTE Mind that perhaps an alarm delay has been set. Also remember to restore the original settings after the test!

Regularly check the function of the water level or flow sensor to make sure that in case of lack of water the sensor gives the signal that leads to the controller stop.

Simulate lack of water by briefly interrupting the water supply. This must lead to a switch of the level sensor or a decrease of the flow signal, and the message „ext. controller stop“ or „no water“ must appear in the display.

Maintenance of the measurement

NEW: **Apart from AUTO and MAN you can now select the new mode HOLD. In that mode, the controller is OFF, and additionally the current output is fixed, and the limit values are deactivated. This allows maintenance without causing alarm in a central control unit. The HOLD mode is selected from the main display with key ▶ just as the modes AUTO and MAN.**

Regularly clean the metallic surfaces of the conductivity electrodes. Remove fat and grease with a common dish detergent. Use diluted hydrochloric acid or vinegar against scale. Rinse carefully with water afterwards.

The c value of the sensor can change during use, due to coatings or aggressive cleaning. These changes can be compensated by readjusting the c value in the menu.

If you have to exchange a sensor, make sure that the replacement sensor is appropriate for your application and corresponds to the equipment used. For example, do not use inductive sensors with conductive instruments.

For optimum accuracy adjust the c value whenever you change a sensor - or an instrument!

Regularly clean filters, flow sensors, and fittings.

Set-up

Follow the instructions of this manual. Carry out all steps described. Check both the measured values and the settings before you activate the controller.

Disposal:

For disposal please notice that the instrument contains electrolyte capacitors which have to be disposed separately.

10. Service

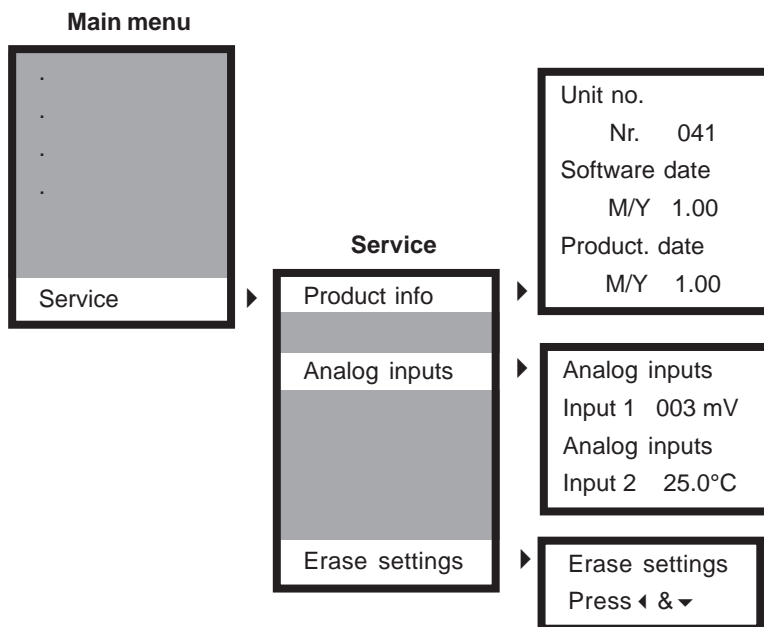

In this menu you will find information which is especially important for any inquiries, updates or problems.

Product info

These figures allow a precise identification of the instrument (hardware and software).

Analog inputs

Here you can see the raw data the instrument obtains from the sensors. They are not influenced by compensations or calibration and offer valuable information in case of problems with the measurement or the instrument.

If you have difficulties interpreting this data, send them to your supplier together with the instrument data - he will know what to do.

Erase settings (reset)

With this function you can erase all customer settings and restore the original at-works data.

The process takes some 30 seconds. When it is finished the display will show the measured value, and the controller will switch off.

Index

A

Alarm	
Errors	34
Limit values	33
Power failure	35
Analog output	32
Averaging	23

B

Bus address	32
-------------------	----

C

Cell factor	22
Code	20
Connection diagram K 100 W	15
Connection diagram K100	14
Connections	10
Controller	
Acting dimension	26
ON/OFF controller	25
P controller	25
PI controller	25
Controller output	32
Controller settings	
Impulse-frequency controller	27
ON/OFF controller	26
Pulse-pause controller	28
Current output	32

D

Digital input	29
Dimensions	11
Display contrast	37
Dosing control	31

E

Erase settings	39
External controller stop	29

F

Fuse	37
------------	----

H

Hysteresis	26
------------------	----

I

Impulse-frequency controller	27
Installation K 100	12
Installation K 100 W	13
Interface	7

K	
Keys	16
L	
Language	20
Limit values	33
Location	8
M	
Maintenance	37
Measuring range	22
Menu	
Basic settings	18
Main menu	18
Menu overview	19
P	
Parameter setting	17
Password	20
Product info	39
Protection class	8
Pt100	24
Pulse contact	35
R	
RC filter	10
Registration output	32
Relay	
contact rating	8
Relays	7
Manual operation	30
Status of the relays	16
S	
Sensor check	34
Serial interface	7
Service	39
Set points	25
Software version	5
Start delay	
Alarm	33
Controller	29
T	
Technical data	8
Temperature compensation	24
Z	
Zero-point correction	23

Customer settings - for reference!

Instrument:

Identification / location:

Type: Date of installation

Instrument no..... Software version

Measurement:

CM (conductive) IL (inductive) c-value...../cm

0 - 20 MΩ 0 - 2 μS/cm 0 - 20 μS/cm 0 - 200 μS/cm

0 - 2 mS/cm 0 - 20 mS/cm 0 - 200 mS/cm 0 - 2 S/cm

Temperature compensation:

Manual Automatic

Temperature: °C Correction °C

Compensation:

pure water linear Temperature coefficient:% / °C

Current output:

0-20mA 4-20mA for: Meas. value controller S1 controller S2

Begin:

End:

Controller:

Controller S1	Controller S2
Direction: <input type="checkbox"/> raise <input type="checkbox"/> lower	Direction: <input type="checkbox"/> raise <input type="checkbox"/> lower
Set point:	Set point:
Hysteresys	Hysteresys
P range	P range
Integral timesec.	Integral timesec.
Pulse pause time..... sec.	Pulse pause time sec.
Min. pulse sec.	Min. pulse sec.
Pulse frequency*100/h	Pulse frequency*100/h
Dosage check min	Dosage check min

Start delay:

Delay time min.

Alarm:

Limit S1 Limit S2

Dealy time min.

Digital input:

Normally closed Normally open

Interface RS 485:

Bus adress
